

Your Gateway to North, Central and South America

Editorial:

What Is Demolition Today?

pages: 16-17

Site Report:

The Robot From Ipanema

page: 21

Reports:

Doing by Learning

pages: 22-26

Putting the Trust in the Americas

pages: 28-30

Doing More with Less

pages: 32-35

Show 'Em How It's Done

pages: 54-56

Clearing Up for Florida

pages: 82-85



pages: 68-73

**Cut costs.
Pulverize projects.
Crush deadlines.**



The industry-leading **XP Mobile Shear** delivers power and performance for increased reliability, uptime and profit

The **GDR Demolition Recycler** is the all-purpose processing and cutting attachment that minimizes dust, noise and flying debris while maximizing productivity in high-reach and standard demolition projects

The **GSG Scrap Grapple** is a low-maintenance, high-capacity orange peel grapple designed for high volume scrap yard processing

The **LXP® Logix Processor** features pulverizer, concrete cracker and shear jaws that change-out in 15 minutes providing ultimate jobsite versatility

Genesis is a global leader in the design and manufacture

of high quality, high performance shears, concrete processors and grapples for the demolition industry. With tools in operation worldwide, look to Genesis attachments for greater project flexibility, higher productivity and increased profits.

Genesis attachments are available throughout North, Central and South America. To learn more, visit genesisattachments.com or call 888-SHEAR-IT in North America and 786-459-0483 for Central and South America.



GENESIS®
The Promise of Performance.

1000 Genesis Drive / Superior, WI 54880 USA / Tel: 715.395.5252

888-SHEAR-IT (743-2748) / youtube.com/genesisattachmentswi / genesisattachments.com

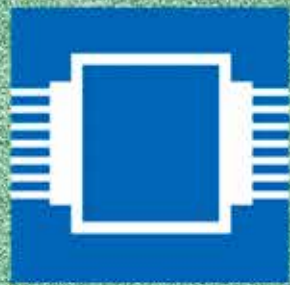

ONLY WIRE

WIDECUT

18:19



CONCRETE WIRE



Product Code - C6



STEEL WIRE



Product Code - HT2



SUPER WIRE



Product Code - C14

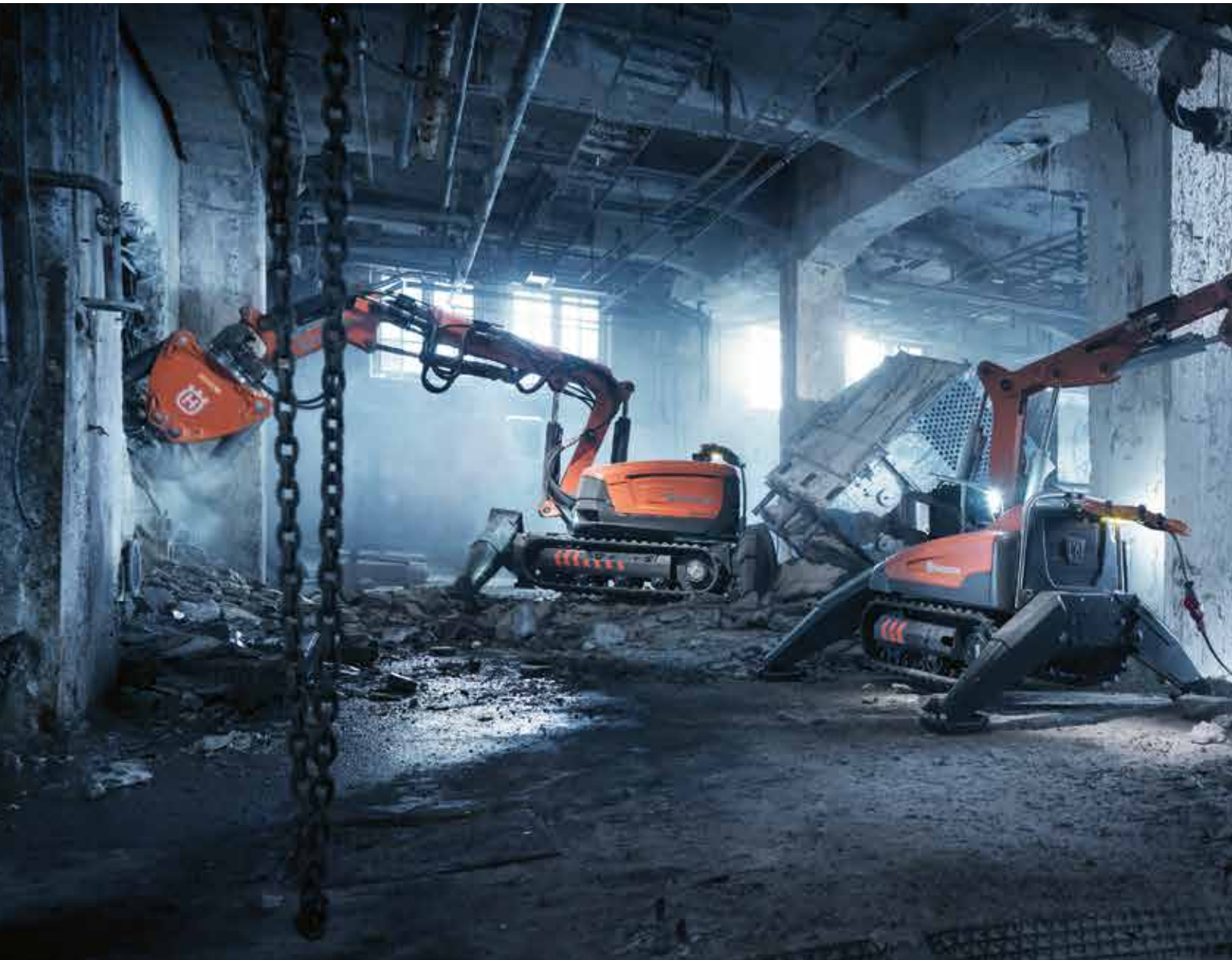

**Husqvarna DXR demolition robots -
the power of intelligence.**



The remote-controlled demolition robots from Husqvarna are the very latest in demolition machines. They are the obvious choice for users who want a maneuverable, highly powerful and stable machine with a long reach. Husqvarna's DXR machines have the market's most modern and easy-to-use remote control with unrivaled user-friendliness and functional design. All this, combined with Husqvarna's expertise, know-how and global presence mean you are assured of highly accessible and competent service and support.

HUSQVARNA CONSTRUCTION PRODUCTS

17400 West 119th Street • Olathe, Kansas 66061 • T 800-288-5040 • F 800-825-0028 • www.husqvarnacp.com
2077 Bond Street • North Bay, Ontario P1B 4V7 • T 800-461-9589 • F 800-825-0028 • www.husqvarnacp.ca
Copyright © 2013 Husqvarna AB (publ.). All rights reserved. Husqvarna is a registered trademark of Husqvarna AB (publ.).

INDECO DO IT BETTER

**CHOOSING INDECO MEANS
CHOOSING THE QUALITY
OF A GENUINE MADE
IN ITALY PRODUCT**

Whether it's breakers, shears, fixed or rotating pulverizers, the multifunction, compactors, demolition sorting grabs or pedestal boom systems, choosing Indeco means choosing the quality guaranteed by the "Made in Italy" label. And for us, that quality guarantee means direct control of each stage in the manufacturing process; a perfect blend of industrial technology and craftsmanship; design, engineering and implementation of solutions to meet the specific needs of our users; use of exclusive special materials based on our own patents; stringent testing and excellent after sales support. Because here at Indeco, we enjoy doing things well. Or rather, better and better. Quality is an attitude.



 **INDECO**
YOUR PARTNERS IN DEMOLITION

Professional Demolition Americas Magazine

Postal address:
Riverbends Publishing, LLC, Pda Magazine,
P.O. Box 552, Nokesville, VA 20182, USA

Phone: +1 703 392 0150

E-mail Editorial Office:
editorial@pdamericas.com

ISSN Registration: ISSN 1650-979X

EDITORIAL STAFF

Senior Editor: Jim Parsons
jim.parsons@pdamericas.com

Editor-in-Chief: Jan Hermansson
jan.hermansson@pdamericas.com

Assisting Editor-in-Chief
Anita do Rocio Hermansson
anita.hermansson@pdamericas.com

Editor North America: Jim Parsons
jim.parsons@pdamericas.com

Editor South America: Luiz Carlos Beraldo
luiz.carlos.beraldo@pdamericas.com

Correspondents:
Andrei Bushmarin
andrei.bushmarin@pdamericas.com

Mikael Karlsson
mikael.karlsson@pdworld.com

Heikki Harri
heikki.harri@pp1.inet.fi

Barbara Grace
barbara@cmma.org.au

Kevin Mayhew
kevinm@addixion.co.za

SALES

Sales Director North & South America
Darren Dunay
Riverbends Publishing, LLC, Pda Magazine
P.O. Box 119, Westwood, NJ 07675, USA
Phone: +1 201 781 6133,
Fax: +1 201 664 1829
darren.dunay@pdamericas.com

Sales Representative South America
Antonio Carlos Gogola

Sales Europe and rest of the world
Phone: +46 8 585 700 46
sales@pdamericas.com

Publisher
Jan Hermansson

The magazine Pda, Professional Demolition Americas is published four times per year in North and South America. The annual airmail subscription rate is US\$ 45. All subscription correspondence should be directed to: The subscription department, Riverbends Publishing, LLC, P.O. Box 552, Nokesville, VA 20182, USA. Or sent by e-mail to info@pdamericas.com. Pda is mailed by second class postage. ©Copyright Riverbends Publishing, LLC, 2013. Printed in the US.

Cover photo: The mountain Corcovado with the statue Rei de Redentor in Rio de Janeiro, Brazil. ©Dreamstime Inc.



Contents



Your Gateway to North, Central and South America

9	<i>Editorial</i> "What a Great Time to be Part of the Demolition Industry!"	59	From Spain to the World, Sima Sets Itself Apart Integrated Wallsaw from Pentrunder	28	Putting Its Trust In North and South America
16	What is Demolition Today?	67	Marathon and Rhino Tools Land in the Americas	32	Making More from Less
10	<i>Business</i> Chukar Waterjet Exhibiting at OTC2013, Houston KPI-JCI and Astec Mobile Screens Hires Dave Cooper Kralicek Retires from Kolberg-Pioneer Ashine at Bauma China JCB Wins Deal for 1,000 backhoes	74	New Hercules Line of Grinders From Klindex Genesis Creates a New Dimension in Mobile Demolition Shears Ruwac USA introduces propane powered vacuum	38	The Home of Diamond Wires
12	Genesis Attachments Expands with Bane Machinery Warnecke to Direct Sales for Blount's ICS Business Brokk Adds Extensive Industry Experience to U.S. Sales Team C&D World 2013 in Tampa the Largest Ever Montecalvo Named President of CDRA Jeff Kroeker Elected New NDA President	75	New Technology for Floor-Covering Removal	44	Chinas Brightest Shining Star
13	NDA Names Six 2013 Scholarship Winners	77	Demolition and Recycling Pavilion at Conexpo-Con/Agg	55	Show 'Em How It's Done
15	Ashine Success in WOC 2013 VINCI Chooses Blaxtair to Protect Its Operators in Chile VDMA Opens Office in Brazil Volvo CE Inaugurates \$100 Million North American Expansion	79	Quality Made in Germany for the World New Diamond Segment Grinding Systems	60	Curators of a Concept
51	Construction Unemployment Drops to 10.8 Percent, Lowest May Mark In Five Years as Industry Add Job And Hours for the Month and Year Over Year	81	Blastrac Grinder and Shot Blaster Demarec Debuts New Mobile Rail Cutter Doosan's new Wheel Loader DL250 Two New Dust Suppression Units from Duztech	68	Brazil Continues Its Fast Expansion
18	<i>News</i> A Busy Bauma for Husqvarna Means More Productivity for Contractors	86	Hartl Debuts New Bucket Crushers and Screeners Down to the Wire with Allied Gator's Shear Solution	82	Clearing Up for Florida
27	Aquajet Launches World's Smallest Hydrodemolition Robot	98	Smart Control solutions for Mobile Machinery	96	Scanmaskin is Setting Up Grinding and Polishing Center for the Americas
47	Genesis Attachments New Subsea Shear Can Operate at Deep Depths	22	<i>Reports</i> Doing by Learning	21	<i>Site Report</i> The Robot from Panama
50	New Demolition Power from Finland				
58	ICS Diamond Tools Range			53	Restoring a Port Dock in Rio de Janeiro
				57	What Else Can Portable Grinding Machines Do? PG280: A New Venture in the Brazilian Rental Market
				76	Hydrodemolition & Jackhammers Go Head-to-Head in Toronto
				87	Automized Mist Blankets Dust
				88	Silent Demolition in Australia
				90	Brokk Takes J.R. Ramon & Sons to New Heights Making a Molehill Out of a Mountain
				91	Midwest Demolition Firm Takes Advantage of High-Performance Dust Suppression Terrco Helps Even the Score for a Power Plant's Floor
				93	<i>Feature</i> On A Roll: Pda Showcases a Bounty of New Excavators





86"
Blade
Capacity

WSE2226

**The World's Most Powerful, Reliable
Wall Saw System**



Optimized wireless remote control for better mobility and safety along with a lightweight control unit that allows operations at 16 and 32 amp.



**26kW - The Highest In The Industry
35HP at The Output Shaft**

POWER

Significantly increased cutting performance thanks to Tyrolit P2 Technology with permanent magnetic high cycle motor

RELIABLE

Get higher productivity due to the reduced service costs and maintenance-friendly design



“What a great time to be part of the demolition industry!”

Dear Readers!

Though not fully recovered from the recession or insulated from Europe’s economic difficulties, the economies of the Western Hemisphere are, on the whole, on the rise, which is good news for all construction-related trades. New and long-postponed projects alike are moving forward, a new sector is rapidly evolving around the growing popularity of concrete flooring, and yet another product innovation seems to arrive nearly every day.

Yes, there is no shortage of good news about demolition work. And that’s a big reason why you’re holding the debut issue of Professional Demolition Americas (PDA).

If you’re familiar with our flagship publication Professional Demolition International (PDI), you already know that for more than a decade, we’ve been the premier source of information on what’s happening in the demolition, concrete sawing and drilling, concrete floor grinding and polishing, recycling, industrial cleaning and soil remediation work around the globe.

PDA will strive to provide the same degree of quality, up-to-the-minute coverage, but focused exclusively on news and trends driving this dynamic industry in North and South America. Our editorial staff, led by veteran industry correspondent Jim Parsons, is well-versed in all facets of the demolition industry, and the issues that are of the greatest interest to contractors, equipment

manufacturers, and customers.

Already, there’s plenty to talk about. The most recent trade shows, World of Concrete and Bauma, enjoyed their best attendance in several years, with visitors rewarded with an array of new product introductions and enhancements.

In the U.S., several states have implemented new funding strategies to jump-start their highway and bridge restoration programs, while Brazil is bustling with a variety of projects leading up to next year’s World Cup and the 2016 Summer Olympics.

Contractors are shifting their energies from simple survival to finding ways to improve their productivity and competitiveness, attract and retain labor, comply with environmental and health/safety regulations, and make the wisest investment in equipment and other resources.

And, few jobs can be considered “routine” in demolition work these days, as mega-projects, site constraints, and access issues continue to challenge contractors’ professional skills and innovation.

All of this, and more, will be coming your way in this and future issues of PDA. And we’re confident that you will like what you see, and want to learn more.

So welcome, and thank you for reading PDA!

Best Regards from The PDA Team

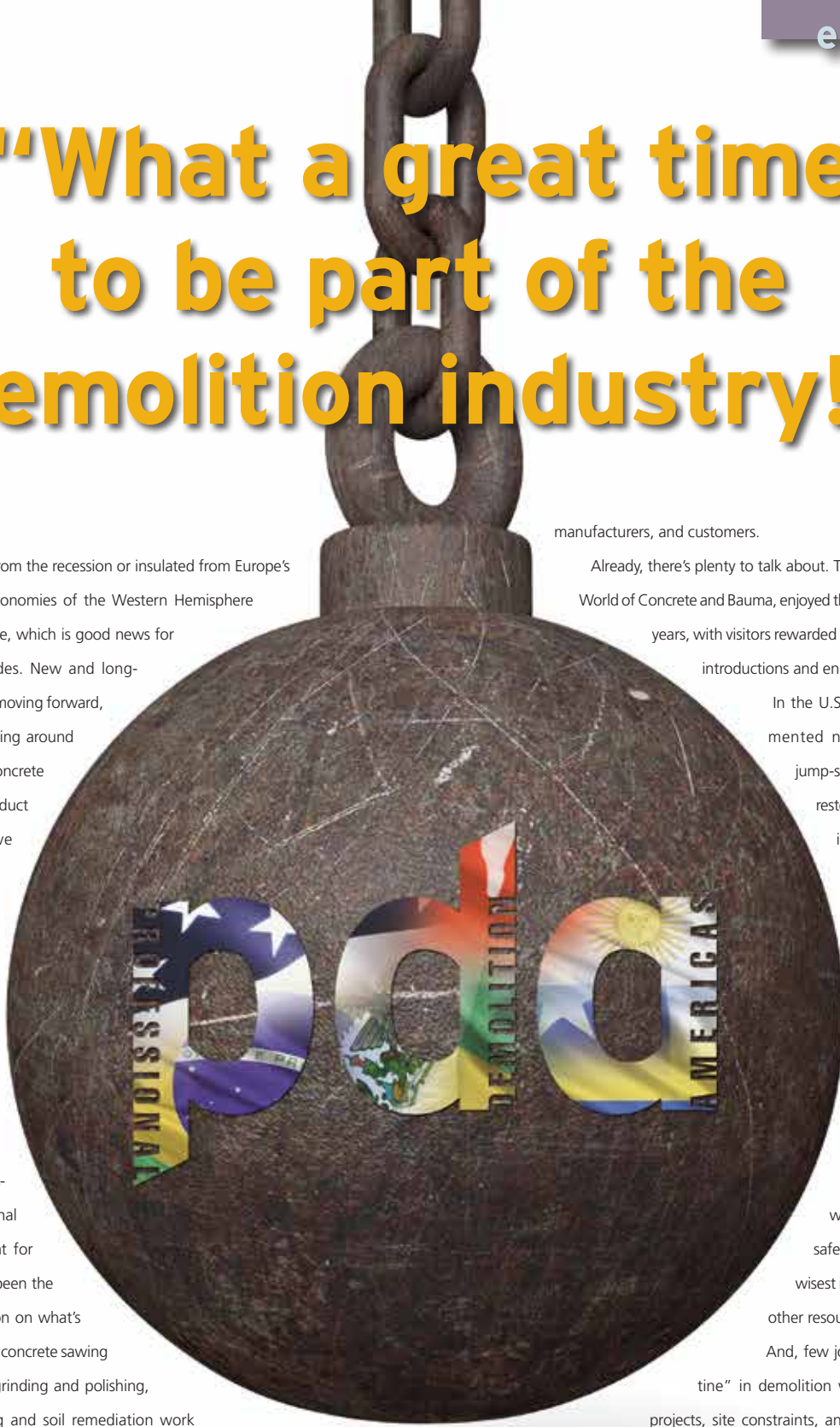

Chukar Waterjet Exhibiting at OTC2013, Houston

Chukar Waterjet, Inc., an industry leading manufacturer and applications consultant for subsea ultra-high pressure waterjet equipment, is exhibiting its innovative deepwater subsea waterjet system at the OTC2013 Offshore Technology Conference, May 6-9 in Houston, Texas. Look for Chukar Waterjet in Booth 546. Chukar Waterjet offers underwater waterjet cutting and blasting equipment capable of operating at depths of more than 9,800 ft (3,000 m). Effective at cutting steel up to 10 in (250 mm) thick or waterjet blasting at pressures up to 55,000 psi (3,800 bar), Chukar's subsea waterjet equipment has numerous applications for deepwater emergency response operations, salvage operations, and rapid de-mobilization operations. It can be used to blast away coatings and marine growth to inspect welds, or as a cutting tool in emergency response and salvage operations.

Waterjetting equipment also may be used to provide turbulence in a stream of methanol for hydrate remediation, an application Chukar developed in emergency response to the Gulf oil spill, when the company was asked to rapidly manufacture a system to clear a clogged containment system nearly 5,000 feet (1500 meters) underwater.



Waterjet technology has numerous advantages over conventional subsea cutting and cleaning tools. Unlike conventional tools, the tools used in a waterjet system cannot bind in the cut, jeopardizing asset integrity. Waterjet cutting also reduces the hazard of igniting trapped pockets of gas during cutting.

For more information about Chukar Waterjet, visit www.chukarwaterjet.com or call 763/497-8749.

KPI-JCI and Astec Mobile Screens Hires Dave Cooper As New Graphic Designer

David Cooper has joined KPI-JCI and Astec Mobile as graphic designer. The addition of Cooper is part of the company's ongoing strategy to build a complete team capable of producing all advertising and promotional material. Cooper is responsible for producing promotional and advertising material for KPI-JCI and Astec Mobile Screens' line of equipment for the aggregate, construction,



paving and recycling industries. He will also assist in any production art for the company's authorized dealers.

Prior to working for KPI-JCI and Astec Mobile Screens, Cooper served as owner and creative director of Dave Cooper Creative, a freelance advertising and marketing firm.

"We were incredibly fortunate to find Dave Cooper to work as our department's graphic designer," said Lisa Carson, marketing manager for KPI-JCI and Astec Mobile Screens. "Dave's skills as a graphic artist, combined with talents in audio and video production and Web management, makes him a perfect fit for our team."

As an innovative, high integrity manufacturer, KPI-JCI and Astec Mobile Screens develops quality, state-of-the-art products and has the ability to engineer custom products because of a highly qualified engineering staff. The company proudly manufactures its products in Yankton, S.D.; Eugene, Ore.; and Sterling, Ill. For more information, call 605/668-2524, or visit www.kpijci.com.

Kralicek Retires After Four Decades of Service to Kolberg-Pioneer, Inc.

Kolberg-Pioneer, Inc. (KPI-JCI) warmly thanks Dennis Kralicek for more than four decades of service, and wishes him success and happiness in his retirement. Kralicek, who retired in early January, worked for Kolberg-Pioneer, Inc. for more than 41 years, starting at the age of 19 when he moved back to his hometown from Sioux Falls, S.D. He spent his entire career building conveyor undercarriages, along with training five different supervisors over the course of his career. Kralicek is one of 107 employees who have been inducted into Kolberg-Pioneer, Inc.'s Quarter Century Club, which has honored employees for 25 years of service since its inception in 2000. Sixty members are currently employed at the company. Company president Joe Vig said the high number of Quarter Century Club members reflects a positive work environment that encourages employees to stay and grow with the company.

"It is incredibly gratifying to have employees like Dennis Kralicek, who are so

committed to the success of this company," Vig said. "We strive to provide an enjoyable, rewarding work experience for our associates, and I believe that is the reason behind our success in maintaining a large number of long-term employees. We greatly appreciate the service of these individuals. Without dedicated employees like Dennis, our company would not have seen the growth and development we've experienced at our facility since it began in 1965."



Ashine at Bauma Shanghai 2012

Chinese diamond tool manufacturer Ashine welcomed dozens of visitors to its Bauma Shanghai exhibit to discuss current trends in concrete flooring, and learn about the company's diamond tools that offer a total solution for surface preparation, concrete/terrazzo grinding, and polishing. The highlight of the Fair was the unexpected opportunity for Ashine to assist one of China's leading floor grinder machine manufacturers. While demonstrating how their machine polished the floor in a concrete formwork, but the resin tools fell off color on the concrete and glazed. The company had heard about Ashine, and asked if they could use the Ashine Resin Polaris Pad to repolish the surface. We happily obliged, and the result turned out great—NO color fall-off, NO glaze, and even better gloss! Everyone on hand was deeply impressed. After testing, several Chinese and worldwide equipment manufacturers expressed interest in working with Ashine. In addition, a Chinese distributor of an

American floor chemical brand praised our company's professional approach and strong R&D capabilities in concrete/terrazzo floor grinding and polishing.

JCB Wins Deal for 1,000 backhoes

JCB has won a massive order for more than 1,000 of its iconic backhoe loaders in a deal designed to transform the rural economy of Brazil. Brazil's Ministry of Agrarian Development has signed a tender for the JCB backhoes worth more than US\$61 million. The landmark order for the 3C machines comes as the company marks 60 years of backhoe loader production. The 1,000 machines, which will be manufactured at JCB's new \$100 million factory in Sao Paulo, will be delivered throughout 2013 and put straight to work improving rural roads to ensure food produced for sale gets to market much quicker. The latest order comes after JCB Brazil successfully supplied more than 1,000 backhoes last year to the same customer as part of the first phase of the development of rural roads.

"This is a very important deal for JCB and we are delighted to have secured the tender for a second year running," according to JCB CEO Alan Blake. "It is huge testament to the quality and versatility of JCB's backhoe loaders, and it's fantastic to win an order of this size as we celebrate 60 years of backhoe loader production this year."

Adds JCB Brazil Managing Director Carlos Hernandez, "It is a great honor to have been chosen again to supply another 1,000 backhoes that will be used to improve the infrastructure and services of the smaller municipalities. We are really pleased we can contribute to the economic development of Brazil, particularly to support the agricultural sector."

A third of all farms in Brazil are family enterprises in remote areas of the country where the road network needs to be upgraded. The purchase of the machines will help facilitate that development, and meet federal government growth plans. The machines will be used in more than 1,000 municipalities, most of which have fewer than 50,000 inhabitants. JCB will provide training for machine operators as well as maintenance and technical support.





DUZTECH

Do it with water



DUST SUPPRESSION WITH FAN MACHINES



UF RANGE

DUST SUPPRESSION
WITHOUT WETTING

FIXED AND MOBILE
SYSTEMS



FIXED NOZZLE
SYSTEMS



Genesis Attachments Expands Texas Dealer Network with Bane Machinery

Genesis Attachments of Superior, Wisc., has named Bane Machinery as its exclusive dealer in northeast Texas. With locations in Dallas, Ft. Worth, and Tyler, Bane Machinery is a multi-generation dealership representing leading manufacturers including Kobelco, New Holland Construction, Link-Belt, Kawasaki, and Sennebogen. Bane Machinery will offer the full line of Genesis products and provide service, rental and product support.

"We look forward to providing our customers top-quality Genesis solutions for their attachment needs coupled with the after-sale support they have come to expect from our family's business," says Scott Bane, President of Bane Machinery.

"Bane Machinery's focus on and experience in the demolition and recycling industries make them well-suited to represent Genesis Attachments," adds Joshua Stubblefield, Genesis south central regional manager. "Their dedicated staff of knowledgeable professionals has been working in these industries for multiple decades, and they understand customer needs and expectations."

www.genesisattachments.com

Warnecke to Direct Sales for Blount's ICS Business

Blount International, Inc., has tapped Kevin Warnecke to serve as Director of ICS Sales for the Americas. Warnecke's



responsibilities will be to serve the markets of the Professional Sawing & Drilling Contractors, General Construction and North American Exports across the U.S., Canada, and South America.

A 23-year employee of Blount, Warnecke has served as a member of CSDA's Board of Directors, and currently chairs the organization's Training Committee.

Blount sells products in the concrete cutting and finishing construction markets, and is the market leader in manufacturing saw chain and guide bars for chainsaws. With a global manufacturing and distribution footprint, Blount sells its products in more than 115 countries. Blount markets its products primarily under the OREGON®, OREGON® PowerNow™,

Carlton®, Woods®, TISCO, SpeeCo®, and ICS® brands.

www.blount.com

Brokk Adds Extensive Industry Experience to U.S. Sales Team

Brokk, Inc., has announced two additions to its U.S. sales team. James "Cat" Catalanotto is the company's new regional sales representative for the New England states, while Jeff Keeling has been named regional sales manager for the Midwest.



James "Cat" Catalanotto.



Jeff Keeling.

Peter Bigwood, Brokk's vice president of sales and marketing for North America, says Catalanotto's and Keeling's wealth of experience with customers in two of Brokk's key markets "makes them ideally qualified to convey the value Brokks bring to a wide range of demolition and construction projects."

Catalanotto resides in Boston where he owns and operates EMCAT, LLC, a manufacturer's representative company that works with several other complementary brands, including Dixie Diamond Manufacturing. He brings 22 years of sales experience that includes roles with Husqvarna Construction Products, and Pro-Companies.

Having first encountered Brokk machines on Boston's massive Central Artery/Tunnel Project (a.k.a., the "Big Dig") in the 1990s, Catalanotto is excited about seeking out the kinds of challenges that only Brokk's compact, remote-controlled machines can handle.

"Brokk machines have proven their unique capabilities on some of the largest projects in the world," he says. "As the largest and most experienced specialty robotic equipment company in the industry, Brokk also has earned its reputation as the cream of the crop for support after the sale. I'm proud to be working with Brokk on the front lines with our customers."

A resident of Olathe, Kan., Keeling brings more than 25 years of industry knowledge to his new role including experience with Husqvarna, Volvo Construction Equipment, and Hilti. In addition, he served as executive vice president for Magnum Diamond & Machinery, his family-owned concrete saw and diamond blade manufacturing business. There, he gained an in-depth understanding of the concrete cutting and demolition industry.

After the family manufacturing business was sold to DIMAS, now Husqvarna, Keeling worked with his father in their own sales business, Precision Demolition. It was there that Keeling was first exposed to Brokk machines serving as a distributor of the equipment.

Keeling was involved with the Concrete Sawing and Drilling Association (CSDA) for many years, serving on its Board of Directors from 2004 to 2006.

"Having been in the concrete industry for more than 20 years, I feel I have a solid grasp of the challenges Brokk customers face," he says. "I am looking forward to helping them find solutions to their challenging applications."

C&D World 2013 in Tampa the Largest Ever

By the time C&D World 2013, the Annual Meeting of the newly rebranded Construction & Demolition Recycling Association, closed its doors at its recent meeting in Tampa, Fla., it was the largest show in the 20 years the event has been held. More than 300 attendees and the largest exhibit floor ever were hallmarks of the show.

In addition, the CDRA's Convention Committee put together an expanded program that featured a dual track set of programs, providing attendees with additional information opportunities. The well-attended program covered concrete recycling, asphalt shingle recycling, carpet, and plastics recycling. And, there was an economic forecast on public infrastructure spending, plus an inspiring presentation by Jorge Caspary, Director of Solid Waste for the Florida Department of Environmental Protection, about the state's requirement on recycling 75% of all C&D waste—an idea that had many in the audience wanting to move their recycling operations to the Sunshine State.

A highlight of the event was the inaugural C&D Recycling Hall of Fame presentations with four inductees: Mason Brown, Big City Crushed Concrete; William Guptail, General Kinematics; Anthony Lomangino, Sun Recycling; and Louis Sanzaro, Ocean County Recycling Centers.

Two other awards were presented at C&D World 2013. Chery Companies, Houston, Texas, won for C&D Recycler of the Year, with Leonard Chery accepting. Michael Dinneen, Agg Rok Materials, Grove City, Ohio, was honored as CDRA Member of the Year.

In 2014, the CDRA will co-locate C&D World with ConExpo-Con/Agg in Las Vegas, which runs March 4-10.

www.cdrecycling.org

Montecalvo Named President of CDRA

At the recently completed C&D World in Tampa, Fla., Valerie Montecalvo, president of Bayshore Recycling, Keasbey, N.J., was named the president of the newly renamed Construction & Demolition Recycling Association. She is first woman to hold the position in the organization's history.

"The CDRA is a dynamic, rapidly growing organization that promotes the materials companies like ours are turning into usable end products that help promote environmen-

tal stewardship," says Montecalvo. "I look forward to working with the CDRA Board of Directors to continue that growth and to serve the C&D recycling industry."

Jason Haus, CEO, Dem-Con, Shakopee, Minn., was elected CDRA vice president; and Patti Hamilton, Vice President, Marketing and Communications, Sun Recycling, Lantana, Fla., was elected Secretary/Treasurer. John Adelman, President, CPCR Group, now becomes Association Past President.

Two new members were added to the organization's Board of Directors: Ken Hoving, President, K Hoving Companies, West Chicago, Ill.; and Bruno Lagace, President, Sparta Innovations, Notre Dame, N.B., Canada.

www.cdrecycling.org

Jeff Kroeker Elected NDA President

Jeff Kroeker of Kroeker Inc./Demolition & Recycling Contractors, Fresno, Cal., has been elected President of the National Demolition Association (NDA), the leading trade organization for the global demolition industry. He was elected at the NDA's 40th Annual Convention in San Diego.

Other changes to NDA Executive Committee are the election of Peter Banks of CEI Boston LLC, Norfolk, Mass., as Vice President; Scott Knightly of EnviroVantage, Epping, N.H., as Secretary; and Christopher Godek of New England Yankee Construction LLC of Milford, Conn., as Treasurer.

Don Rachel of Rachel Contracting LLC, St. Michael, Minn., is Past President of NDA, while Michael R. Taylor CAE serves as Executive Director.

The Association has appointed a number of new members to its Board of Directors. They are Rick Givan of LVI Environmental Services, Inc., Denver, Colo.; Anthony Pirrone of Ontario Specialty Contracting, Inc., Buffalo, N.Y.; Andrew DeBaise of Rocky Mountain Recycling Inc., Commerce City, Colo.; and William Sinclair of Safedem Limited, Dundee, Scotland.

The National Demolition Association is a non-profit trade organization representing



Jeff Kroeker, President, National Demolition Association



#1
GRINDER/
POLISHER IN
MIDSIZE
MACHINE
CATEGORY
USING THE
MODEL 2000



VOTED #1
IN CUSTOMER
SATISFACTION
TWO YEARS IN
A ROW IN THE
ELECTRIC
CATEGORY



1936 TO 2013 AND STILL THE BEST



MODEL 6200



MODEL 3100-3P
SELP PROPELLED



MODEL 3100-3P



MODEL 2000-LP



MODEL 2000



MODEL 701-S



EDGER



TERRCO® INC.

222 1st Avenue NW - Watertown, SD 57201

Phone (605) 882-3888 - Fax (605) 882-0778

Email: info@terrco.com - Website: www.terrco.com



approximately 1,000 U.S. and Canadian companies and many international firms that are involved in the demolition process. Membership includes demolition contractors, general contractors, civil engineering firms, and recycling, landfill, and salvage operations.

The association's efforts help members stay abreast of environmental, regulatory and safety matters, keep regulators informed about issues facing the industry, increase public and industry awareness, and provide members with networking opportunities and information on the latest technical advances in equipment and services.

www.demolitionassociation.com

National Demolition Association Names Six 2013 Scholarship Winners

The National Demolition Association has awarded scholarships to six students exhibiting high academic achievement and a commitment to the community. [Images available upon request]

"We're pleased to present these scholarships to students who have demonstrated a commitment to serve the local community while maintaining a high level of academic achievement," said Michael R. Taylor, CAE, Executive Director of the Association.

The Bill and Wanda Baker Scholarship was presented to Ryan Mitacek of Glen Ellyn, Ill. Ryan is a graduating senior at

Glenbard South High School in Glen Ellyn. He was nominated for the scholarship by NDA member company Robinette Demolition Inc., Oakbrook Terrace, Ill.

One of two National Demolition Association Scholarship swas awarded to Laura Kowalik of New Alexandria, Pa., a graduating senior at Derry Area High School. She was nominated by NDA member company Noralco Corporation, Pittsburgh, Pa. The second scholarship goes to Marc Petrine of Midlothian, Va, who will graduate this year from Maggie L. Walker Governor's School in Richmond, Va. Marc was nominated by NDA member company, S.B. Cox Inc., of Richmond.

The NDA Southern California Chapter Scholarship was presented to Nathan Wolf of Fontana, Cal., a student at the University of California, Los Angeles. Three D Service Demolition Contractors, Pomona, Cal., nominated Nathan for the scholarship.

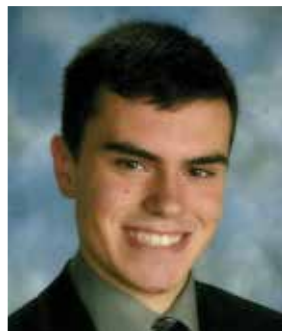

Ryan Mitacek.



Nathan Wolf.



Mark Petrine.



Jovana Stijovic.



Laura Kowalik.



Jelena Stijovic.

The Patrick H. O'Rourke Scholarship was awarded to Jovana Stijovic of Garfield, N.J., a student at Bergen County Community College. She was nominated by NDA member company Brandenburg Industrial Service Co., Chicago.

The Sims Adams Recycling Scholarship, offered to qualified students through the NDA, was given to Jelena Stijovic, Jovanas sister, of Garfield, N.J., also a student at Bergen County Community College.

www.demolitionassociation.com



DESCUBRA O QUE HÁ DE NOVO

Dê uma olhada definitiva e bem de perto no futuro da construção.

A CONEXPO-CON/AGG representa uma grande revelação do que há de mais novo e avançado em equipamentos, tecnologia e produtos de construção. Desde equipamentos de terraplanagem a inovações surpreendentes de que você nunca ouviu falar, tudo está reunido em um único local para ajudá-lo a trabalhar com mais inteligência.

Faça uma pré-inscrição para obter atualizações da mostra em conexpoconagg.com



**SE FOR NOVO,
ESTÁ AQUI**

Ashine Success in WOC 2013

At World of Concrete 2013, Ashine welcomed current clients to its booth to discuss the latest trends in concrete floorings, and learn about the company's diamond tools that offer a total solution for surface preparation, concrete/terrazzo grinding, and polishing.

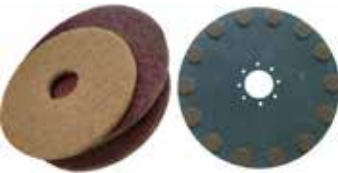

Ashine also introduced its new products that solve the most up-to-date concrete problems in the market.

A few days before the show, a US distributor tested the Ashine Generation IV Resin Pad on a demonstration test floor. The result was outstanding—no swirls, very good clarity, shining by just one pass, and an average gloss meter reading of 55.

Another product that attracted the attention of many visitors was Ashine's A-PAD series for high-speed burnishers, buffers, and auto-scrubbers. The series includes A-Pad Hybrid, A-Pad Resin, and A-Pad Impregnated. A-PAD is used to achieve high shine and for daily maintenance, making it an ideal choice for new floors; remodeled big box, supermarket, or mall stores; wavy floors; and dye/polish.

Ashine also developed a toolbox to make the contractor's work more convenient. Designed like a safe box, the toolbox is used to store and protect the diamond tools. The clients were deeply impressed with all the company's new offerings, resulting in a number of new product orders for their contractors.

www.ashinediamondtools.com

VINCI Chooses Blaxtair to Protect Its Operators in Chile



In tunnel projects, the collaboration between machines and men on the ground, coupled with cramped conditions and low light inside the tunnel, considerably increases the risk of accidents considerably. Placing the safety of its employees on site at the top of its priorities, So when global contractor VINCI Construction Grands Projets was hired to dig two new tunnels in the El Teniente mine in Chile, the company wanted to select a reliable detection system to reduce these risks.

The ideal choice proved to be Blaxtair®, an intelligent onboard camera that detects pedestrians, helps avoid collisions between moving machines and operators on the worksite. Developed by French technology manufacturer Arcure, the Blaxtair® system detects, precisely locates, and identifies a wide range of obstacles. It is the only device of its kind that can distinguish a pedestrian from another object in real time, and readily alert the operator to take action.

After testing Blaxtair® camera on two diggers being used in the Lee Tunnel project in London, VINCI Construction Grands Projets fitted the device on more than 50 vehicles at the El Teniente site, including hydraulic diggers, dumpers, loaders, forklifts, and mixers produced by the industry's leading manufacturers.

"Blaxtair® not only offers the same functions as a reversing camera coupled with an obstacle detection radar, but above it specifically detects pedestrians," notes Marc Bohin, Equipment Manager of VINCI Construction Grands Projets. "The system is a great help to the driver in detecting pedestrians and obstacles and thus reduces the risks of accidents."

www.arcure.net

VDMA Opens Office in Brazil

German-based VDMA construction equipment and building material machinery manufacturer has opened an office in Sao Paulo, Brazil.

Brazil has become very important for the German engineering sector during the past few years. In fact, Germany is the second most important machine supplier for the country, behind the US. More than one fourth of Germany's exports are machines and plants. Materials handling technology, power transmission engineering, and machinery for food processing machinery and packaging are in great demand.

The new "Director executive do VDMA Brasil," Thomas Junqueira Ayres Ulbrich, has



German and Brazilian roots, as his mother comes from Salvador, Bahia. Ulbrich grew up in Germany and studied in Bonn. He spent his internship in Rio de Janeiro.

Ulbrich worked as a lawyer at VDMA from 1989 to 2000. He has had "full sympathy" for the mechanical engineering sector since that time, working for some European mechanical engineering companies since the turn of the millennium.

"The desire for a second country led me back to Brazil, together with VDMA," Ulbrich says. "I am looking forward to being able to support all of the German-Brazilian mechanical engineering companies, and I will be glad to be at your disposal in the centre of Sao Paulo and sometimes in Frankfurt as well."

"The VDMA is glad to have found a committed colleague who knows not only Brazil very well but also the mechanical engineering sector with its special singularity", said Dr. Hannes Hesse, Executive Director of the VDMA.

Volvo CE Inaugurates \$100 Million North American Expansion

On March 21, 2013, Volvo Construction Equipment (Volvo CE) cut the ribbon on its \$100 million expansion program at its Shippensburg, Pa., facility. In addition to the official opening of a new 36,000 sq ft (3,345 sq m) headquarters building for the Americas, the event also marked the start of wheel loader production at the Shippensburg facility.

On hand for the inauguration ceremony were U.S. Federal Highway Administrator Victor Mendez, Pennsylvania Department of Community and Economic Development Secretary Alan Walker, and Swedish Ambassador to the United States Jonas Hafström, along with 1,000 employees and many other distinguished guests.



The investment affirms the Volvo CE's long-term confidence in the North American market and consolidates its North American operations onto one site. The opening of the new building also marks the successful relocation of the sales office from Asheville, N.C., to Shippensburg, Pa.

"This should serve as a very clear signal that Volvo CE is committed to this market and in a better position than ever before to offer our customers products that are made by Americans, for Americans," said Volvo CE President Pat Olney. "Longer term, building machines closer to our customers will have a positive impact for U.S.-based suppliers, who will gain more business; for customers, who will enjoy shorter lead times; and for Volvo CE, which will be less exposed to currency swings."

Wheel loader production will initially start for the L60-L90 range of loaders.

"These machines are in high demand in North America," says Sean Glennon, vice president of operations at the Shippensburg facility. "The investment we make in these smaller models will allow us to eventually launch into the bigger machines and meet a wider scope of customer needs."

Glennon added that localized production will also help the company become more flexible and responsive to its customers in the region.

The new Americas headquarters serves both the North and Latin American business of Volvo Construction Equipment. Additionally, the site's global technology center employs around 200 people and provides development expertise to the wider Volvo business.

In addition to wheel loaders, the Shippensburg facility also makes more than 50 models of road machinery, including soil and asphalt compactors, motor graders, pavers, screeds, and milling machines. Operations include welding, large machining, paint and assembly.

Volvo CE's Shippensburg facility has been committed to producing quality construction equipment for nearly 40 years. A \$30 million, 200,000 sq ft expansion was completed in June 2010 and included a new assembly hall and materials building. The addition of two smaller production buildings will bring the total size of the expanded facility to 650,000 sq ft (60,386 sq m).

Future plans call for the addition of a world-class customer center in the Shippensburg area in the first quarter of 2014.

What is Demo

Demolition today is such a wide concept, spanning a variety of methods and techniques. During the last 20 years, the profession's development among contractors has been quite diversified. While some contractors tend to narrow themselves and concentrate on one or a few services, the majority embrace the wide spectrum of services.

Demolition has previously been considered a rather small sector within the huge building and construction industry. Likewise, demolition workers have also struggled with a rather poor status—the result of both being in the sector itself, plus the lack of regulations. Once, almost anyone could start up a demolition firm and start bidding on jobs. But things have changed. And they continue to change across every facet of demolition around the world.

The sophisticated contractors

Having focused specifically on the demolition industry as a writer since the early 1990s, I think it is amazing how this industry has changed. Even the term "demolition" has evolved for me over the years. We've come a long way from the old days when one used a sledgehammer or an excavator with an attachment to knock down a structure. To work as a demolition specialist today is a far more complex undertaking, involving a number of different techniques and methods, and an ever more diverse range of machinery and equipment. I would say that overall, the modern demolition contractor is very sophisticated, and possesses a great deal of knowledge. Indeed, today's demolition contractors are more diversified than an ordinary building and construction contractor taking on a number of different tasks. Often, the demolition work can be more complex than to build from scratch. In Europe, for instance, regulations are very strict in terms of the methods for taking down a building. The demolition process must be strictly monitored with demolition plans; safety plans; plans for how the work will affect the environment in terms of noise, vibrations and dust; demolition certificates; and so forth. The demolition debris needs to be cleared and taken care of, either recycled for new use or brought to a landfill.

What falls under the demolition concept today?

First, the dominant material in all sorts of demolition projects is concrete. Processing concrete today involves many different types of methods. In fact, it has become a project in and of itself, requiring a skilled contractor to decide what type of method should be used. Cost is, of course, a big issue, vary-

ing greatly depending on the method used. Labor cost varies from country to country, as do the relative machine vs. labor costs. Laws and regulations in the country where the demolition will take place also play into the decision of what method to use. In both the US and Europe, laws and regulations are more or less synchronized between jurisdictions. If a large building is to be totally removed from a site, there are many ways to do it. For a very tall building, you can use implosion the surroundings allow, or knock it down with a high-reach excavator and hydraulic breakers if noise is not a big issue. In some rare cases, a crane with a demolition ball is still used.

Implosion is more expensive, but the demolition process itself goes much quicker than with traditional machine-based methods. If the building is in a sensitive downtown area with offices and hospitals close by, "silent" demolition equipment such as hydraulic concrete crushers, multi proces-

sors, sorting grabs, etc., will likely be preferred. When implosion and long-reach excavator methods are not allowed due to environmental or other reasons, there are several other options.

For example, the building can be cut down using concrete sawing and drilling methods. This is a very controlled method where the different pieces are cut down with wall saws, wire saws, flat saws, or similarly equipped diamond tools. In the old days, hydraulic concrete cutting equipment was quite bulky, requiring operators to drag and set up heavy machinery around the work site. Often in the US, the large hydraulic power packs were left on the ground with hydraulic hoses hanging out from the windows or other openings of the building.

Today, the use of hydraulic equipment concrete cutting is diminishing rapidly all over the world, replaced by high-cycle (HF) or high-frequency electrically-driven equipment. Equipment weight has been cut tenfold, and the new types of HF equipment are just as powerful if not stronger than their hydraulic predecessors. Both set-up and disassembly are fast and easy, making the equipment highly mobile on a jobsite. HF technology also uses separate power packs, but a few integrated wall saw units have appeared on the market in recent years.

As everything is in "one piece," the concrete cutting a very fast and smooth process.

We also see a lot of handheld power cutters with diamond blades or diamond chains cutting through the reinforced concrete creating blocks that can be lifted safely to the ground with a crane.

Most HF wall and wire saws are operated via remote control using a cable or radio, not unlike another popular and safe remote controlled demolition method—the demolition robot.

Though remote controlled mini-excavators are increasing in use on demolition sites, demolition robots are the preferred choice because they are purpose-built with much stronger booms and greater flexibility. Demolition robots are available in size from compact models up to 10t, and have a reach up to 26ft (8m).

The remote control function keeps the operators on a safe distance from the actual demolition situation with no risk of being hit by falling debris. The remote controlled machine can also work on thin joists. And when taking down a large building, the demolition robot can be lifted to the top level, then work its way down in step with the building itself. The demolition debris is often channeled down elevator shafts and removed using compact loaders.

The latest iteration in "remote control" demolition has been developed by the Italian demolition contractor Despe. Called the "Despe Too Down Way", this controlled demolition method for demolition of skyscrapers hardly affects the surrounding area, yet effectively takes care of all rubble. This method is also considered very safe for both the demolition workers as well as the public.

Partial demolition projects most common

The more predominant—and often, more technically challenging—types of projects today are partial demolition and renovations. Rather than the total demolition of a building, structures are only partially removed, placing greater demands on the contractor's knowledge and skill level. In order to carry out these projects, many different types of methods interact—excavators, hydraulic attachments of different types, remote controlled demolition robots, concrete sawing and drilling systems, cranes, loading equipment, etc.

Often before the actual demolition work starts, the contractor must first eliminate hazardous materials such as asbestos, PCB, metals, oil, and other substances. When a structure is down, the underlying soil may require treatment as well. In almost all parts of the world, material recycling is becoming more and more important. Often, it's highly regulated and even mandated. Demolition debris is first crushed with



Demolition Today?

pulverizers, and then ground in a mobile recycling crusher. If the material is to be reused on the same site, the recycling is sometimes done directly on the jobsite or brought to a separate location for processing. Today most building materials can be recycled. Concrete, bricks, wood, gypsum, and other types of light building material are ground and reused, while metals may be sold to a scrap handler. Different types of screens and windscreens that separates very light material are becoming more and more common on a demolition site. This was a very difficult task in the past, leaving the contractor little choice but to transport light material to a dump.

The level of use of recycled material varies from country to country. Most countries in Europe for instance today allow use of recycled concrete as landfill for construction of new buildings, sidewalks, parking places, etc. In some countries, recycled concrete is allowed for the base material of roads. This extended use of recycled material today means a valuable income for many demolition contractors, allowing them to invest in different types of recycling equipment.

Another demolition method that can't be overlooked, yet plays an important role in terms of concrete repair, is hydrodemolition. Historically carried out by solely specialized demolition contractors, hydrodemolition is the optimal method for removing damaged concrete and replace the area with fresh material. Hydrodemolition does not cause microcracks that result from using conventional heavy equipment, thereby preventing the intrusion of dirt and water that accelerates deterioration. This demolition method is perfect at sites where water is not a problem (e.g., repair of turbines in power plants, piers, parking decks, bridges, concrete roads, nuclear plants, etc.). Lately, both traditional demolition and concrete cutting contractors have begun to offer hydrodemolition services when the project allows.

Concrete floor grinding and polishing

Another contracting service on the rise among demolition and concrete sawing and drilling contractors in the US, Australia, and Europe is concrete floor grinding. When a building is renovated, the floors need to be restored. Most have an underlying concrete base that has been covered with tiles, carpet, epoxy or some other type of coating that needs to be removed—often a very time-consuming job. Many contractors specialize in this work, but often a demolition or concrete sawing and drilling contractor will be asked to do the job. Fortunately, there are a number of very efficient floor grinding machines equipped

with a planetary disc system and diamond tools that efficiently remove the coating.

Over the last 10 years, the advent of new machines makes it possible to polish up a concrete floor to a shining surface that has the same finish as terrazzo, marble or granite surfaces. There are many advantages to using polished concrete as a final flooring product instead of putting a new layer of epoxy or other type of coating.

Concrete floor polishing has become very popular in the Americas, but also Europe, Southeast Asia, and China as well. We're seeing more and more demolition and concrete cutting contractors offer both concrete grinding and polishing on top of their core services. And why not? They are already on the site, and they have the machines that can be used both for grinding and polishing.



Safety and health

No discussion of demolition is complete without considering the working environment. Virtually every aspect of the concrete demolition work—grinding, polishing, breaking, sawing, drilling, and recycling creates a lot of dust, and in some cases, slurry.

A lot has happened related to safety and environmental issues during the last ten years. First, contractors have become much more aware of the health risk and the effects that dust, noise, vibrations, and the demolition work in general can have on their workers. The number of trade associations has increased as well, and all have helped contractors address safety and environmental issues by offering courses and training.

There is also a greater awareness among the contractors in general. In terms of products, the focus now is on devices that handle dust both for indoor and outdoor operations. Indoors, we have seen an increasing number of manufactures of efficient pre-extractors, dust extractors, cyclones and air cleaners with HEPA filters, and a number of wet vacs.

The professional brands have substantially improved the indoor climate for the contractors—a big change from the times when an inexpensive vac was bought and used during a project, then simply dumped when the job was done. You can imagine just little these types of vacs did to truly eliminate dangerous particles.

Today, professional dust extraction equipment use pre-filters and HEPA filters to capture the dust before workers inhale it. As mentioned before water mist cannons today handle the outdoors dust



more efficiently. There are a large number of suppliers of this type of equipment today in particular in the US and Europe. Also preventing dust spreading outdoors has become a big issue. Today there are a number of manufacturers of so called water cannons. In order to minimize the spread of dust outdoors, suppression cannons hurling a light mist of micro-size water droplets



to bind the dust have become a very popular tool during the last years. These devices can reach distances of more than 300 feet (100m), with horizontal spreads of nearly 1,000 feet (300m). In this type of demolition task, fewer workers need to be located in the danger area.

Safety has taken a big step forward in our business in general. Machine manufacturers have invested a lot in making safer and more environmentally friendly equipment. This ongoing effort is carried out in close co-operation with trade associations around

the world. Operators of machines enjoy better protection today due to more rigorous safety systems.

That brings us back to the original question, "what is demolition?" The answer, it seems, has never been more diversified. Demolition occupies a broad spectrum of services that offer great potential to contractors interested in broaden their perspectives. True, the majority of contractors still focus on a few operations within the broad concept of demolition, with some specializing in just one or two operations.

But during the last decade we have seen a number of demolition contractors aiming to become more complete in their services described. For them, the potential for further growth and opportunity is enormous **(pda)**



jan.hermansson@pdamericas.com

A Busy Bauma for Husqvarna Means More Productivity for Contractors

One of the busiest manufacturers at the spring Bauma trade show in Europe was Husqvarna Construction Products.

Husqvarna Construction Products had a magic week at Bauma, the world's largest trade show for construction equipment in last April. This year's show became the largest ever with 3420 exhibitors exhibiting on 6135428.94 sq ft (570,000 sq m) and attracting more than 530,000 visitors. Most of the diamond tool and concrete sawing and drilling equipment manufacturers were as usual gathered in hall A1 at the Munich, Germany exhibition center. One of the companies that stood out was Husqvarna Construction Products displaying a number of new products.



The new ring cutter from Husqvarna.

"We brought a big number of number of news to the show. Some of the new products we showed earlier this year at the US show but we had quite a number of products displayed for the first time at Bauma", said Husqvarna Construction Product's President Anders Ströby.

Ströby was very satisfied with the exhibition and the visitors showed great interest for Husqvarnas products. He was in particular very satisfied that so many visitors came from South America to see the show. "South America is with out any doubt a great market for us with an even greater potential. We have very good representation there and all our product seem to be very well appreciated. The US market is very strong for us now and last year was our best ever", said an optimistic Anders Ströby.

The big news at Husqvarnas booth at Bauma was the new HF (High frequency) platform. The manufacturer released a new module concept where all methods interact, core drilling, wall sawing and power cutting. Husqvarna showed the new drill system DM 650, the new wall saw WS 220 and the new power pad PP 220 (the wall saw will be released only in the fall). The new high-cycle K 6500 Ring ring cutter was released that can cut over its own center of the blade. Everything can be easily packed on a new smart trolley that is easy to move around on the worksite. But that is not where the news flow stops.

K 6500 high-cycle power cutter

Tapping the new generation of high-frequency technology, for example, the new Husqvarna K 6500 and the corresponding PP



65 power pack offer one of the most effective electric power cutters on the market today. In addition to its superior ergonomics and high power-to-weight-ratio, the K 6500 may be operated using both 3-phase (7.3hp/5.5kW max output) and single-phase (4hp/3kW max output). The K 6500 uses 15in (400 mm) blades for a cutting depth of 5.6in (144mm).

“The K 6500 is optimized to quickly cut through a large amount of concrete while at the same time being kind to users due its superior ergonomics,” says Johan Simonsson, Husqvarna’s Global Product Manager for Power Cutters. “The K 6500 is also fitted with an LED load indicator, which displays the current load on the machine and allows users to maximize cutting speed to obtain the most efficient cutting.”

At 22lb (10kg) each, the power cutter and power pack are easy to carry and handle. With a durable design and an encapsulated motor, the K 6500 has few maintenance and service requirements. The air cooled PP 65 can be used in environments where water usage should be kept at a minimum. Keeping the power pack detached from the power cutter also minimizes its exposure to dirt and vibrations, ultimately leading to longer product life.

DM 650 drill motor redefines versatility

Another addition to Husqvarna’s high-frequency line is the new DM 650 electric drill motor—so versatile that it may well be the only machine a drilling professional needs.

The powerful high-output electric drill motor delivers 8hp (6kW) on the spindle using 3-phase and 4hp (3kW) using single-phase power. Weighing only 35lb (16 kg), the DM 650 offers an outstanding power-to-weight-ratio as well. Its torque boost can reduce speed in order to increase drilling torque when encountering steel reinforced substrates.

The DM 650 is ideal for all core drilling from 4in (100mm) to 24in (600mm) diameters. The 18-step adjustable rpm range ensures optimal speed for all drill bit dimensions. When used with the corresponding Husqvarna DS 450 stand, the DM 650 performs effectively on reinforced concrete, brick and other building materials. It is also well suited for heavy-duty applications like water evacuation, ventilation and plumbing channels and gas supply pipes.

The DM 650 is equipped with the advanced Elgard™ electronic overload protection system that makes drilling at maximum pressure possible without risk of machine overload. LED load indicators guide the operator to attain optimal performance.

As with the K 6500 power cutter, the DM 650 utilizes the separate air-cooled PP 65 power pack.

Technical specifications

Rated voltage (V):	
3-phase	480
1-phase	230
Spindle speed (rpm)	
1 speed	125-240
2 speed	270-540
Spindle thread size (in/mm)	1.25/31.75 7 UNC
Rec. drill diameter, max (in/mm)	24/600
Weight (lb/kg)	31/14

Diagrip2™ —a new dimension in cutting blades

Speaking of next-generation technology, Husqvarna has built upon its Diagrip™ 3-dimensional diamond matrix cutting blade technology to create Diagrip2™, which will cut up to 30 percent faster than existing blades on the market.

Diagrip2™ features a high concentration of diamonds, with cutting edges optimally and evenly distributed in the segments around the tool, maximizing the cutting capacity of every diamond. This optimal positioning means that the diamonds are constantly exposed, resulting in a very even and



Smart and efficient core drilling.



Husqvarna Construction Product’s President Anders Ströby showed great satisfaction over the new line of products that the company displayed at the German trade show Bauma.



with distinct end positions, the machine is easy to set at the exact water flow for each application, which minimizes water waste and slurry. The new tank air purging solution ensures optimal air supply to the fuel tank while also preventing dust from getting in. Together with the heat-resistant belt guard, operators enjoy maximum operating times and extended product life.

The new K 760 retains a number of features from the previous model, including a engine, the Active Air Filtration™ filter cleaning system, and SmartCarb™, the advanced carburetor that automatically controls fuel/air mixtures to ensure maximum engine power at all times.

Technical data

Cylinder displacement (cm3)	74
Power (hp/kW)	5/3.7 kW
Diamond blade (in/mm)	12-13.5/300-350 mm
Cutting depth (in/mm)	4-5/100-125 mm
Weight (lb/kg)	21.6/9.8

Remote control robot family welcomes new members

Four years after launching its first remote controlled demolition robot, the DXR 310, Husqvarna has added two new machines to meet a wider range of applications.

The DXR 270 and DXR 300 feature a compact (2.5ft/78 cm) wide chassis that fits through most doorways and construction lifts. The low height also provides the operator a free view over the machine while working, making operations more efficient, safer and helps give it a low center of gravity.

Both robots are also equipped with new wider outriggers that provide increased stability and greater load-carrying capacity. And, the DXR 270 and DXR 300 are each are controlled by an easy-to-use remote control with a 3.5in (90mm) color display and Bluetooth technology. The control system is adapted to handle tough demolition environments characterized by high vibrations, concrete dust and water ■

Technical specifications	DXR 270	DXR 300
Power (hp/kW)	25.5/19 kW	29.5/22
Weight (lb/kg)	3,858/1,750	4,321/1,960
Reach (ft/m)	15.7/4.8	17/5.2

**The new generation of diamond tools
Diagrip 2.**

powerful sawing with a minimum of unnecessary friction. The segments are also designed to facilitate slurry transportation, which ensures cutting speed and a longer tool life.

“Traditionally, when it comes to diamond blades, there has been a trade-off between speed and product life. What you increase in speed you lose in tool life, and vice versa. But the Diagrip2™ offers an excellent balance of both”, says Michel Hubermont, Husqvarna’s Head of

Diamond Tools.

K 760 is a perfect fit for the modern worksite

Reflecting the growing awareness of environmental issues, for example, Husqvarna introduced the new K760 power cutter, a useful all-round machine well-suited to most types of concrete jobs, as well as cutting pipe, asphalt and metal. The K 760’s air-cooled 2-stroke X-Torq™ features a new cylinder and cooling fin that combine to reduce emissions by 15 percent compared with its predecessor model. This innovative design also ensures optimal operating temperatures, and makes the machine less sensitive to climate variations.

An optimized digital ignition system offers better startability and smoother engine operation, resulting in very low vibrations and significantly reduced user strain. Other ergonomics improvements on the new K 760 include a new adjustable magnesium blade guard that gives the cutter better balance, and makes altering cutting positions easier. A reversible blade bushing in the guard allows the user to easily switch between blades with different center holes.

To increase usability and dust control, the K 760 features a new wet cutting kit with a progressive valve. Fitted

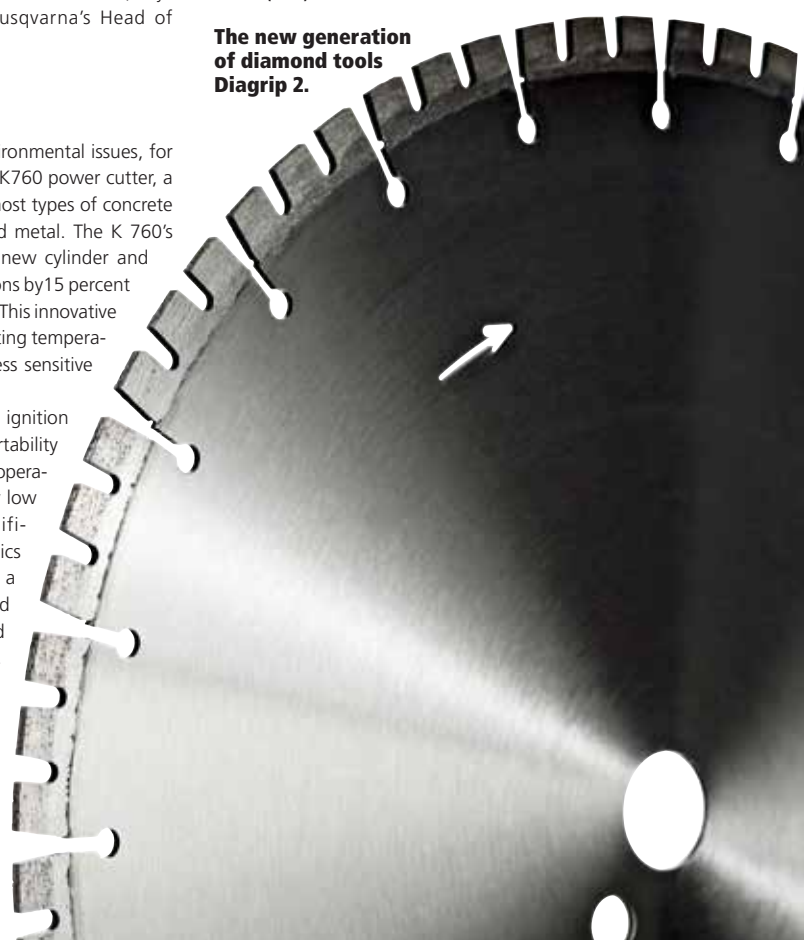

Two brands new remote controlled demolition robots from Husqvarna Construction Products.



The Robot from Ipanema

The first Husqvarna DXR 140 sold in Brazil is already renovating a house in Ipanema, Rio de Janeiro

Ekiye-C, one of the top sawing and drilling contractors in Brazil, bought its first demolition robot—a Husqvarna DXR140—last November to enter in the light demolition business. At that time they said they bought it as a Christmas gift for the company, as they had no pending job for the robot. But, it didn't take long for that first job to arrive. Less than two months after the acquisition, the machine was sent from Ekiye-C's Sao Paulo headquarters to Rio de Janeiro for a demolition assignment.

No noise on Ipanema

The job was to demolish a house located in a residential area in Ipanema, one of the most famous neighborhood in Rio. It



“Tall and tan and young and lovely...”. That is what Tom Jobim and Vinicius de Moraes wrote about the girl from Ipanema in the famous song. To keep the famous Rio neighborhood fit a demolition robot from Husqvarna was used to renovate a residential house.

was on the “Praia Ipanema”, Praia means beach in Portugues, that the famous Bossa Nova composers and musicians Tom Jobim and Venicius de Morais wrote the Bossa “The girl from Ipanema”. At the demolition project in Ipanema the noise level was a restriction imposed by

the neighbors. But apart from the restriction, Ekiye-C needed a high-production machine as the team working on site was relatively small in order to minimize project costs, and .

The demolition of this old house required a compact and powerful machine

to do the job, as the walls were heavily reinforced. The structure also had many confined spaces such as corridors, living rooms, and bedrooms.

A perfect match

The DXR140 was the perfect match for this type of job. Ekiye-C was very satisfied with the machine. The robots automatic breaker lubrication ensured reliability throughout the job, while the market's most modern and easy to use remote control minimized the team's learning curve.

Husqvarna was also proud of this job since it was the first DXR-140 in the country, and sold to one of the company's key accounts of Brazil's growing market for sawing, drilling and light demolition work.

Technical Information DXR 140

Power (hp/kW)	20/15
Reach (ft/m)	12/3.7
Weight (lb/kg)	2,116/960

www.husqvarnacp.com



The DXR 140's compact design make it possible to work in small places.

The powerful demolition robot they could reduce the number of workers in the job site and still increase the productivity.

Doing Learning.

TEXT: JIM PARSONS
PHOTO: HTC

Surface prep pioneer HTC has always looked to its customers to inspire the company's many innovations.

by ng

As the owner of a Swedish cleaning company in the 1980s, Hakan Thysell was doing a good business with floor renovation projects that involved the removal of glue, epoxies, and other coatings using shot blasters and hand tools. But he came to realize that concrete would soon emerge as the final flooring surface, due in large part to its longer life and reduced maintenance needs.

“Tack, men nej tack”

When he offered ideas for getting ahead of this potentially lucrative demand curve to some equipment manufacturers he worked with, however, they politely said thanks, but no thanks. (Or, perhaps more accurately, Tack, men nej tack.) They were big companies with extensive resources, after all, while Thysell was just one contractor with a seemingly limited perspective. Undeterred, Thysell began tinkering with machines on his own. In 1992, he introduced the Dianova, an electric-powered dual-belt, three-head grinder under the name of his own company, HTC. By then, Thysell's vision was already well on its way to becoming reality. Polished concrete was increasingly the flooring of choice across a wide range of new and renovated facilities, and HTC was on its way to becoming a world leader in the nascent surface preparation industry. More than 20 years later, Henrik Rosencrantz, President of the U.S. subsidiary HTC, Inc., recalls that anecdote not simply in response to a question about the company's origins, but rather as a core tenet of its business philosophy.

“Our credo is, ‘we’re innovators not imitators,’” Rosencrantz says. “But if you look at the innovations in our product line, many of them come from customers. For example, our EZchange™ system came from discussions with customers who wanted faster, more flexible tooling change-outs. They talked about the difficulties of getting under shelves and other tight spaces, so we developed the 270 EG Edge Grinder.”

New pre-separator

The most recent World of Concrete saw yet another customer-driven HTC innovation—the Greyline GL PS pre-separator, which adds an extra stage of filtration to dust extractors such as the HTC 80i, and those

**Henrik Rosencrantz,
President of HTC, Inc.**



A perfect set-up for high level concrete floor polishing.

produced by other manufacturers. Along with the convenience of seamless, continuous operation, the pre-separator also reduces a contractor's staffing needs.

"Paired with a remote-control grinder/polisher [another HTC innovation introduced in the early 2000s], you can have one person controlling an entire operation," says HTC, Inc.'s Sales Director Mike Felkley, who adds that the pre-separator is one of the first products in the new Greyline™ series, designed for the rental market.

"We're working on tweaking the electrical system so that the machines will operate across the U.S., especially in residential settings," he says.

HTC, Inc.'s Sales Director Mike Felkley.

Perfectly positioned for service

HTC's reputation for innovation and meticulous attention to detail is greatly appreciated by long-time customers such as Brent Schmiegelow of American Concrete Concepts, Inc., Russellville Ark.

"HTC's equipment is fully tested and refined before it comes out, unlike some companies that test their products on the fly," Schmiegelow says. "You can depend on them to have everything ready. It's quality equipment from day one."

Since its founding in 2004, home for HTC, Inc., has been Knoxville, Tenn. Serving customers in North and Central America, and the Caribbean, the company's 35,000 sq ft facility houses assembly, service, and shipping of HTC's grinders, vacuums, diamond tools, and spare parts all of which are imported from Sweden. A separate 23,000 sq ft

facility nearby houses the U.S. production of HTC's new Twister™ line of chemical-free diamond floor-cleaning pads for the region's janitorial market.

HTC products are sold both direct and via 11 distributors across the U.S. Four members of HTC's eight-person sales team are based in Knoxville, and the nearby junctions of three major Interstates afford easy access to wherever their skills are needed.

"All of our salesmen have mechanical backgrounds, so they actually split their time doing sales and technical support," Felkley says. "They're always accessible when customers need them, even if it means being at a job site during off-hours because that's the only time the contractor can work."

And when the a customer has a problem with an HTC product, first-line telephone troubleshooter Adam Hicks can usually talk them through it, and recommend the next step. "We have good people at every position, from the warehouse to the front lines," Rosencrantz says.

Knoxville is also home to

The popular allround machine HTC 800 RX.



HTC University, the company's three-day training course conducted six times a year, as well as at large industry fairs trade shows. Training director Cliff Rawlings oversees the program that mixes discussions and hands-on experience with operating and maintaining equipment for 23-30 "students" each session.

"The goal of HTC University is to help contractors be more profitable, and expose their workers to both routine aspects and emerging trends in the industry," Rosencrantz says. "We cover all knowledge levels, so even a veteran of the industry is likely to learn something."

HTC tries to take a similar approach to its 12-model product line of professional grinders. Anchored by the benchmark model 800, the company offers manual and remote-control options ranging from the aforementioned 270 EG to the eight-disk, 54.3 in wide 1500iXT ride-on with self-contained vacuum system for large-area jobs.

"We know one size doesn't fit all," Felkley says. "Whatever a contractor's needs are, there's an HTC product that fits them."

Such variety is particularly helpful as those needs change and evolve. Jay Thomason of Industrial Applications, Memphis Tenn., recalls buying one of the first Dianova grinders in the early 1990s when, like other contractors, he was still focused on doing coated surfaces.



Training at the HTC Knoxville premises.

trends is appropriately reflected in HTC's diamond-impregnated Twister™ pads, which were introduced in the U.S. a year after their initial debut in Sweden. And not surprisingly, Rosencrantz says, the idea for reducing the need for chemicals in floor maintenance originated with floor owners.

"Polished concrete flooring itself is inherently green, and the awareness of its value continues to grow," he says. "It's cost effective to own and maintain, and can even reduce electricity use through its high reflective properties. If you can provide that level of care with fewer chemicals, you have a flooring system that's better for the owner, customers, workers, and the environment. Everybody benefits."

New Twister™ products and features are on the way, including a dry-polish system tailored specifically for marble surfaces, more easily identifiable wear indicators, and an improved carrier to increase pad life.

Having helped foster the emergence of concrete polishing as an industry, HTC is also committed with advancing its professional profile. Along with the continuing education efforts of HTC University, the company is a founding member of the Concrete Polishing Association of America (CPAA), which has developed industry guidelines and definitions for various types of polished concrete.

"Even though knowledge of polished concrete has grown significantly in the past five years, the definitions go a long way toward helping floor owners understand what it is they're buying,"



"Back then, everyone was doing shot-blasting, so we were intrigued by a machine that could do both removal and preparation for a new surface," Thomason says. "It was clear that HTC was taking the lead on things, because polished concrete started to take off."

Thomason estimates that polished concrete now accounts for 70 percent of his company's business. His HTC equipment arsenal has grown as well, now totaling include more than 30 grinders.

"They've stayed ahead of everyone by not resting on their laurels," Thomason says. "They're constantly trying to improve, which is important since there are so many other grinders on the market now. What's more, they've become as much a business

partner to us as a vendor. If I get in a bind or need something, they're there to help. You can trust that they'll always do as they say."

Cultivating a greener future for the industry

The awareness of emerging trends inspired by Hakan Thysell more than two decades ago continues at HTC, Inc. The most recent example are supporting "green" environmentally sensitive and sustainable practices of both contractors and facility owners.

"That spans everything from making the equipment more efficient so contractors get more work done faster and with fewer resources, to improving ergonomics for the benefit of the workers' health," Rosencrantz says.

The convergence of these

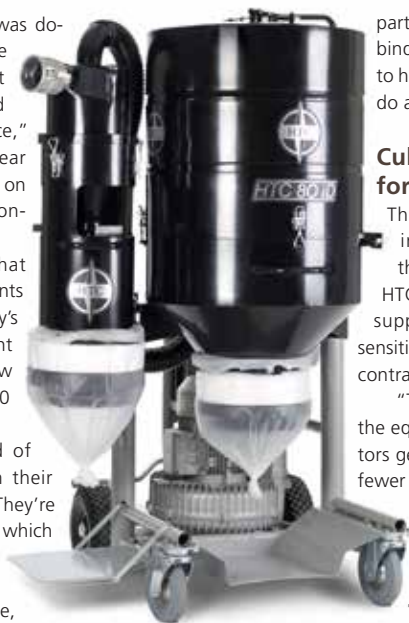

The HTC 80 iD powerful dust extractor.



HTC 270 EG, edge grinder.



Rosencrantz says. "Otherwise, it's abstract."

At the same time, he adds, contractors need a thorough knowledge base in order to help guide owners, not oversell products or methods.

"Our job is to listen, but also provide the training and support contractors need, especially those new to the industry," Felkley says. "Our salesmen are always ready to help on site. We don't want contractors to feel like they're alone."

Schmiegelow has called on HTC numerous times when the perspective of a recognized expert has been needed to assess "problem projects," usually those involving defecting concrete slabs that no amount of polishing will ever meet the owner's expectations.

"The owner may not like what they hear, but they are more willing to accept the situation when they hear it from HTC," he says. "They're a great resource, and always willing to come out and help us with these things."

Being able to count on HTC is important to Schmiegelow as he and other contractors face the combined challenges of a changing industry and an uncertain economy. He sees building renovations and new industrial and manufacturing facilities as the fastest growing opportunity areas for polished concrete.

Schmiegelow also looks forward to more "large-



acreage" products, and the opportunity to utilize his company's three four-head model 950s.

"They have developed products that help us be more productive and get more out of equipment," he says, something that's particularly important since the availability labor "continues to be an issue."

In other words, the polished concrete industry is doing well. Rosencrantz notes that 2012 was a record year for his company and many others, and that he expects the steady growth to continue.

"As the industry moves more toward remote-control equipment, we're working on integrating that feature into more machines," he says. "There's also a lot of product development underway on the diamond tooling side."

HTC's objective, Rosencrantz adds, is to maintain its position as an industry leader and innovator.

"All we have to do is keep listening to our customers," he says. "That won't guarantee our success, of course, but it makes our role as innovators a lot easier." <pd>



Aquajet Launches World's Smallest Hydrodemolition Robot

Hydrodemolition specialist Aquajet Systems AB introduces the world's smallest hydrodemolition robot, the AQUA CUTTER 410, which offers increased versatility, productivity and ease of operation.

At the international show Bauma in Germany in April, Hydrodemolition manufacturer Aquajet Systems introduced the world's smallest hydrodemolition robot. The AQUA CUTTER 410 is ideal for applications in confined areas such as urban concrete sewer pipes, small tunnels, and interiors with restricted space.

With dimensions of just 6.5ft x 2.6ft x 3.2ft (2.0m x 0.78m x 0.99m), the new robot can go through an ordinary door opening and operate inside a concrete pipe, on vertical, horizontal or overhead surfaces. And weighing approximately 2,200lb (1,000kg), the 410 can also operate from scaffolding.

Working typically with between 10,152 and 36,259 psi (700 and 2,500 bar) pressure and 227 to 681 gpm (60 to 180 l/min), the robot handles most concrete removal tasks on floors, walls, and overhead applications. It will also replace many applications currently performed using manual high-pressure handlances operating at 36,259psi (2,500bar) or more; providing a more safe and accurate operation.

Wide tool assortment

The 410 robot features a number of tools,



Aqua Cutter 410 is perfect for really narrow tunneling jobs.

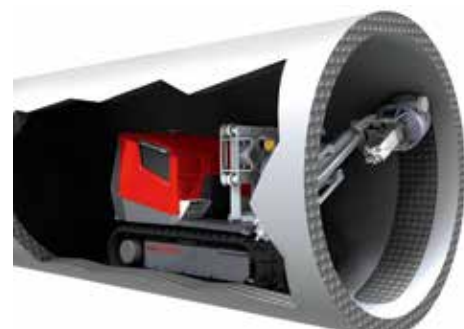

including a rotor for surface preparation and work inside pipes, a single lance with a 5ft (1.5m) front scroud for surface removal, and an hydraulically operated articulated arm with a reach up to 13ft (4m).

The first tool to be released is a tunnel operation kit that can operate in tunnels up to 3m diameter. The kit is based on the Aqua Spine system which makes it extremely flexible since most of the Aqua Spine accessories can also be used. The tunnel kit also features automatic detection of the distance to the tunnel surface, making it easy to operate in uneven tunnel shapes or oval tunnels.

The 410's Power Control Module (PCM) can be disconnected from the tracked crawler, allowing the crawler to be driven into unfriendly environments, such as small tunnels suddenly flooded by, heavy rains.

In this mode, the PCM is connected to the track crawler by a cord for remote control of the removal process controlled remotely.

The rugged 410 robot offers the same reliability, versatility, easy maintenance, and low operating costs as Aquajet's AQUA CUTTER 710 robot, and uses many of the same parts.

The 410 also incorporates Aquajet's EDS Equal Distance System (EDS). Regardless of the set lance attack angle, the system controls and maintains the nozzle distance from the concrete surface. Maintaining an optimum distance, EDS ensures that no power is lost due to the nozzle being too far from the surface which will ensure a 15- to 20-percent increase in removal capacity.

Also included in the 410 is Aquajet's advanced, fully waterproofed Intelligent Sensing Control, which results in a more efficient production with fewer interruptions.

www.aquajet.se

Quite a difference in size between Aqua Cutter 710 and new 410.



Putting Its Trust and South Am

With a suffocating weak domestic market and scattered European market Italian attachment manufacturer Indeco put its trust to North and South America that is showing very positive numbers. About 40% of the company's sales are shipped to North America.

Being an Italian manufacturer dependent on the Italian market is a tough task these days. Or frankly, it is almost an impossible task. The Italian market is experiencing one of its worst economical nightmares in decades. If a manufacturer want to see any chances of survival export is the solution.

Trusting the North American market

"I am seriously very worried," says Michele Vitulano, managing director for the attachment manufacturer Indeco in Bari, Italy, adding that the bad market situation is not limited to Italy.

"All surrounding markets like Spain, Greece and other smaller states are really bad too," he says. "Middle East countries that used to be rather good have become more difficult. One reason is the strong competition from China and Korea."

Indeco puts its trust in some of the more northern European markets

and, in particular, North

and South America. About 40% of the sales are located in North America including some 10% in Mexico.

Sales in South America represent make up 10% of the company's business, but are on the rise.

Europe accounts for about 25% of Indeco's business, while Africa—the fastest growing market—is averaging between 10 and 15%. The remaining

25% is mostly divided between the domestic market in Italy and rest of the world.

Indeco has owned a US subsidiary in Milford, Conn., for more than a decade, and operates four service centers across the country. A new service center recently opened in Portland, Ore. Two years ago, Indeco established Indeco Mexico SA in Mexico

City, with a team of technicians and sales staff plus a large warehouse. The office in Mexico City is also supporting neighboring countries to the south.

Vitulano believes that technicians are sometimes more important to focus on than salespeople. Technical advice and professional support is what the users are asking for. Not that he thinks that his products sells for itself but the sales work is left to about 30 dealers that sell Indeco equipment in the US, Canada, and Mexico.

A complex but growing South American market

South America is a prioritized market sector for Indeco, and the company already has dealers in most South American nations. But, says Vitulano, each country in South America is unique.

"In Europe countries can be different in some ways but the basics of

doing business is the same," he explains. "In South America each country is a unique and quite complex project and very much of the complexity is related to the difficult import legislations."

Argentina has become a very strong market for Indeco, with a dealer located in Buenos Aires and an approximately 60% market share. However, companies need an import certificate for every imported product—something that can take up to two months to secure. Venezuela has a similar requirement.

Brazil is different. The import certificate is not a problem to get but the country's import duty is still horrendous, though it has been lowered over the last decade. However, it also takes a very long time to get products through customs.

"Even though we struggle with these practical and bureaucratic obstacles South America is a very interesting continent right now which in some cases is booming," says Vitulano. "We have very good sales in Argentina, Brazil, Venezuela, Colombia, and Chile at the moment."



ust In North merica

"I am seriously very worried over the market situation in Europe. But we are doing very good in North and South America," says Michele Vitulano, Managing Director for the attachment manufacturer Indeco in Bari, Italy.



New products from Indeco

The focus in Indeco's product development and product range is still hydraulic breakers. But while the company offers a wide variety of breakers, the company has devoted the past decade to widening range with other types of demolition and recycling attachments like concrete cutters, pulverizers, sorting grabs, steel shears, etc. During the spring 2013, Indeco launched several new products:

The new ISS 10-20, small on size, big on performance

This is the smallest shear in Indeco's range designed for 10-ton excavators. Like Indeco's other shears, the latest addition to the range, the ISS 10-20, will also have outstanding cutting force due to a series of special design features. They include exclusive dual-profile piercing tip system, four fully reversible and interchangeable steel blades, a dual blade-guide system, and deep jaw and long blades, and its cutting register adjustment system.

The specific benefits of Indeco hydraulic shears include a regeneration valve that accelerates no-load movement of the jaw, thus speeding up opening and closing. A heavy-duty pivot group keeps the jaws aligned and prevents buckling, while a large, powerful hydraulic cylinder—an exclusive Indeco design— provides enough force to deal with any type of working conditions; and its long-lasting seals that can withstand up to 10,152 psi (700 bar) of pressure.

The Indeco IBS pedestal boom system

Indeco has also launched a new series of high-tech products, designed and tailored to meet customers' specific requirements and individual needs. Produced and marketed a few years ago by Indeco North America and Indeco Australia, the Indeco IBS pedestal boom secondary breaking system looks destined to make a strong impact on many other markets, having already proven to save time and money in many a quarry and mine.

Mounted over the mouth of a primary crusher, the systems reduce bridged and oversized material that slows down crushing operations: In doing so, plant down times can be eliminated. With their unique design and special high-strength steels, the IBS range of pedestal boom systems have outstanding reliability, productivity, and durability, and an excellent quality- price ratio. These improvements result from the use of computational tools such as FEA (Finite Element Analysis), which performs structural and stress tests. This makes it possible to test and improve the product before the start of the manufacturing process.

New line of rotating compactors

The new line of Indeco IHC Series-R rotating compactors has been created to help the contractor to work even under the toughest conditions. These rotating compactors have continuous 360° rotation, which means they can be used wherever the excavator is. The hydraulic fittings are in line with the carrier boom, the hydraulic rotation motor is easy to access; and the upper attachment plate is reinforced.

The IHC compactors efficiently replace traditional hand-held equipment, reducing accident risk. In slope applications, these machines eliminate self-propelled rollers and the risk of rollover. Indeco compactors, mounted straight onto the carrier boom, are hydraulically driven with an oil-bath bearing system. This hydraulic system gives a balanced design of compaction force and vibration speed, achieving the depth penetration needed to reduce air voids and move more material faster **(pda)**

www.indeco.it





Floor Grinders, Dust Extractors and Solutions!

Aquajet Systems has launched the

next generation of Hydrodemolition equipment

Containerized 23 ft POWER PACK

AQUA CUTTER 710 V robot



scan for
MORE
information



the AQUAJET app



Available on the
App Store



Available on the
Android Market

www.aquajet.se

AQUAJET
SYSTEMS AB

PROVEN HYDRODEMOLITION EQUIPMENT

Innovations in productivity, quality and competitive prices make LVS rapidly acquire customers in Brazil. With customers in other countries in South America, Europe and Africa, the goal now is to expand sales of its concrete floor grinding and polishing equipment to the worldwide market.

TEXT: LUIZ CARLOS BERALDO
PHOTOS: LUIZ CARLOS BERALDO
AND DIVULGAÇÃO/LVS

Between two glass walls, a small counter with coffee, teapots, and a plate of fresh grapes await to be tasted by the visitors. When you climb the stairs to reach the corridor leading to the office of Alzira da Silva, LVS's Financial Director, the visitor is tempted to taste a grape. That's when Alzira becomes both a genial host, as well as a manufacturing executive.

"A year ago this premises was a home, a residential building where we used to assemble our machines and take care of all the administrative work," she explains. "Then we decided to take on the task of renovating the company's facilities to create a pleasant and larger workplace, more suitable to receive cus-

Luiz Carlos da Silva, President of LVS, in front of the LVS premises in Curitiba, Brazil.

Doing More

tomers from all over Brazil and, more recently, other countries who want to visit and get to know us and our products better. And, of course, we also needed a larger area for assemblies of machines." Alzira greets us with the simplicity of one who is welcoming guests into her home. The family business environment is an aspect that no one here wants to give up, no matter how the business grows. Her husband and Company President, Luiz Carlos da Silva, started the business. He is currently more focused on customer service and development of product and production.

Started in 1999

LVS produces and sells machines for polishing concrete, marble, granite, and granitina floors and other surfaces; epoxy removal; and floor preparation for application of the epoxy.

The company produces the model LVS 5.5, LVS 7.0, and LVS 8.5, plus parts and accessories used for different types of cutting, sanding, and polishing. The machines are assembled in-house, with parts produced by local suppliers based on Luiz Carlos international patent obtained in 1999.

"Our story has two stages," Luiz Carlos says. "First there was the development phase, assembly of units for testing and then delivery of the first units in 1999. But the company LVS itself began in 2007, with series production and a good portfolio of clients interested in the new product."

Since then, the business has progressed year after year, and the company has increased its market share, which until now was dominated by imported equipment.

"Recently we celebrated the delivery of our 500th machine, to a customer named Jesus," says Alzira. "I think it was a good sign, that he was called Jesus, wasn't it?"

In late February, when she gave us the interview, the company had delivered a total of 530 machines. "We have grown gradually, and in recent years with more impact," Alzira says. "In 2012 we had a weak first half year, but in the second half sales took off. And we started in 2013 with many orders. This year has started much better than last year."

Attending to the demands of the market

Before opening his own business, Luiz Carlos worked at a major manufacturer of construction products, and had constant contact with contractors operating in this sector. Thus, he sought to develop a device that could bring solutions to attend the demand of market—aspirations that he personally identified with the users of the machines.

"First I realized I could make a product with a much low-

er price than the imported ones," Luiz Carlos says. "Then, I could develop my own product. I started to wonder why the machines produced by my biggest competitor had such a higher price. Soon I understood there were reasons for this, details that made all the difference in quality, productivity, durability, and economy."

Ultimately, Luiz Carlos developed product improvements that competitors didn't have. "Today, if you ask a construction company or contractor using my equipment and also the one provided by another brand, he will tell you that my product is far superior," he says. Luiz Carlos explains that in all the details he sought solutions for problems founded in day-to-day by the users of the machines, such as design improvements with better ergonomics to minimize transfer of vibrations to the operator.

"A worker who works eight hours with our equipment ends the day feeling better than he would feel using another brand," he says.

Luiz Carlos notes that LVS concrete floor grinding and polishing machines have a larger diameter than the existing ones on the market. "They are easier to handle, easier to transport as they can be disassembled in parts," he says. "They work on voltage 220/380 VAC, three phase, or 440 VCA custom. We typically offer machines with a frequency inverter speed control and thermal protection."

Changing the planetary disc on the LVS grinders is also easy thanks to a unique system that uses no screws. The large planetary disc is designed so the diamond tool is easy to fit in a in a crib with tapered bevel. To install a grinding or polishing disc, just press it flat from inside to outside. The centrifugal force of the rotating disk causes it to be constantly pressed on the bevel angle plug, keeping it firmly fixed in his crib and eliminating the use of screws or latches. Just a slight hit with a hammer on the back of

"Our 500th machine was sold to a customer named Jesus. I think it was a good sign, that he was called Jesus, wasn't it?"



The largest grinder from LVS, LVS 8.5. Below some of the polishing pads from LVS.



grow with LESS



Different diamond grinding tools from LVS.



Planetary geared grinders.



the piece is all that's necessary to remove it.

"It is much more practical because during operation of change, the equipment may contain clay or mud on the disc, which makes the use of keys difficult," explains Silva.

Another point of pride is productivity. The LVS 85 polisher, with a diameter of 33in (850mm) is a planetary geared machine and therefore leaves no ripples on the surface. It has a capacity of making some 4,300ft² (400m²) of concrete grinding per .

"But it's not just the diameter that makes it more productive," Luiz Carlos says. "I also offer the best domestic and imported grinding and polishing tools to my customers. The tools are tested in our own testing track where we test the machines on many different types of materials such as granite, marble, concrete, and tile."

Luiz Carlos adds that he works with tool suppliers to get the highest quality materials that will, in turn, provide the ideal hardness and sanding ability to give the best result.

"The technology is constantly improving," he says. "I keep myself updated and apply the news in my product."

Customer training

Another difference that sets LVS apart, says Alzira, is the training and after-sales service. "We do not deliver and say 'make good use of this and be happy,'" she says. "We offer training for the customer or operator to use the machine in order to get the best result. Our technical assistance is from our own factory. When the client needs assistance, we send technicians already with the genuine spare parts. For example, right now we are sending a technician to meet our customer in Portugal."

When creating his factory of concrete floor grinding and polishing machines, Luiz Carlos thought to meet initially the Brazilian market. "But given the high quality of our products we are exporting to other countries such as Argentina, Portugal, Paraguay, and Mozambique," he says. "For added versatility, the products are designed to be adapted for use with any kind of steel tool and resin-coated tool."

In the Brazilian market, LVS's more expensive machine is sold for R\$30,000.00—about 20 percent less than the comparable imported models. "We compete with imports," says Luiz Carlos, adding that thought there are no official figures on volumes in this segment, he estimates that his market share in Brazil is more than 50 percent. The concrete grinding and polishing market in Brazil is booming.

"We are in a time of growth in civil construction in Brazil,



Three voltages, 220/380 VAC, 3-phase or 440 VCA.



with major projects such as stadiums and other infrastructure projects around the country," Luiz Carlos says. "This is moving the market forward. We have a customer who is doing polishing floor work at the airport, and another one working hall polishing at one stadium being prepared for the 2014 World Cup, and even a large number of floor polishing in shopping centers, among others.

In 2012, LVS sold 120 units, half of which were the larger capacity LVS 8.5. The intermediate LVS 7.0 accounted for 35 percent of sales, and the LVS 5.5 with 15 percent.

"In 2013 we expect a growth of 20 percent in the domestic market, with exports

holding steady at 15 to 20 percent of our business," Luiz Carlos says. "In addition to our current markets, I'm hopeful we can soon export to the United States and Europe."

As the interview wraps up, Alzira invites me to try the grapes and offers coffee and tea.

"Take a bunch of grapes with you," encourages Alzira. This relaxed family business is another of the secrets of LVS: a lean structure with low costs. The company occupies a building area of approximately 400 square meters and has 10 employees. Luiz Carlos and Alzira's son Vinicius, 26, also works at the company as Industrial Director. Their daughter Rafaela, 20, is studying Civil Engineering at University, but also works mainly with purchase of components and inputs. There is even a younger son, Raphael, 16, who is still in school.

The current facilities can produce up to 300 units per year, more than double what LVS currently sells selling now, in one shift. "But we can operate in two or even three shifts if there is needed," says Luiz Carlos. "Yes we can grow; we just need the orders."

LVS is already planning to introduce a new machine with a diameter of 47in (1200mm) for even greater productivity.

"We are already in advanced stages of development and, if all goes well, we will begin to market soon—by 2014 at the latest," Luiz Carlos says. "And, we are also expecting the launch of a machine to do polishing work." <pda>

www.lvs120.com

Brief Facts

Founded:	1999
Number of employees:	10
Products:	Floor grinding polishing machines in dimensions 21in, 27.5in, and 33 in (550mm, 700mm, and 850 mm), plus complementary grinding and polishing tools
Annual sales:	120 units (2012)
Markets:	Brazil, Argentina, Paraguay, Portugal, and Mozambique

Alzira Aparecida da Silva, in charge of finances at LVS and wife to Luiz Carlos.



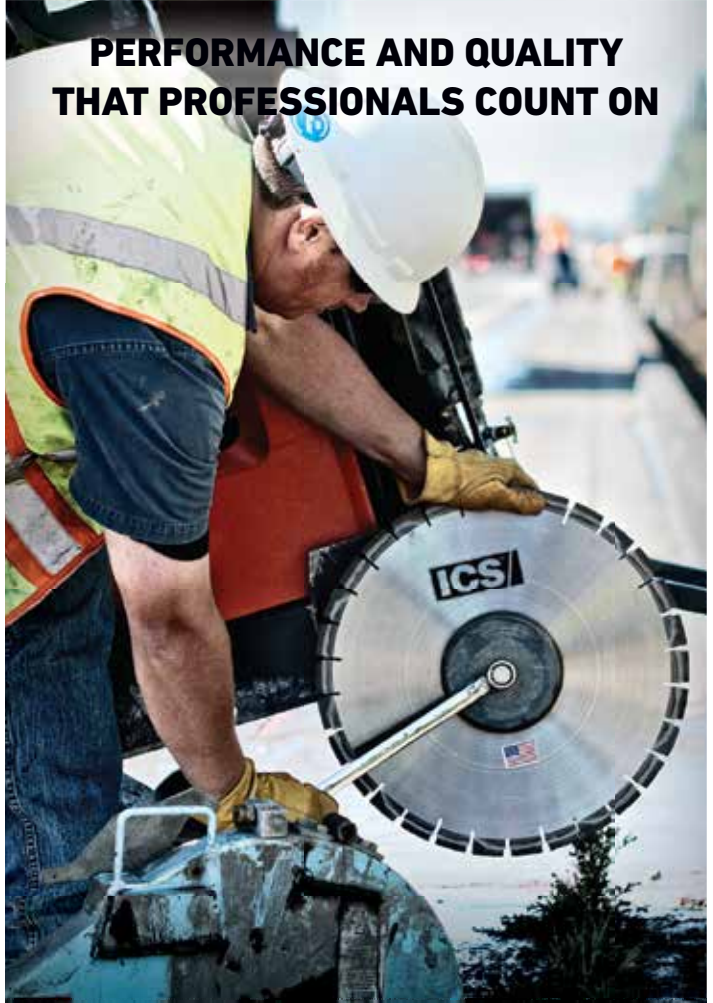

**PERFORMANCE AND QUALITY
THAT PROFESSIONALS COUNT ON**



Luiz Carlos da Silva, President of LVS.

Performance is in the Details

ProFORCE®. The new, full line of American made professional diamond blades and core bits from ICS. Engineered to the highest possible standards for production sawing and drilling.

Contact your ICS sales representative
or call 1.800.321.1240 to learn more.



ICS | Blount Inc. • 4909 SE International Way
Portland, OR 97222 USA • 800.321.1240

© 2013 ICS | Blount Inc. All rights reserved. Pricing subject to change without notice.

With HTC, you're getting more than just quality products - you are getting a dedicated partner.

Unmatched Customer Support & Training

2 Year Warranty

All HTC floor grinders¹ and dust extractors come with a 2 year warranty. Buy with confidence knowing you're purchasing quality products!

Free HTC University Training

Buy a floor grinder and get **FREE** HTC University training². You can even train first and deduct the training fee when you purchase the machine afterwards.

Unmatched

Our sales representatives are dedicated to their customers. They know flooring contractors work long hours - You don't stop working at 5pm, neither do they.

Quality Promise

If you stand behind our machines, we'll stand behind our products. There is a reason why HTC has always been the industry leader, and always will be.

Superior Diamond Tooling Quality

Coatings Removal & Floor Preparation



T-Rex Series



T-Rex Rings



T-Rex Dome



T-Rex Super

Concrete Grinding (soft to very hard)



C Series



CA Series



SF Series



CX Series

Concrete Polishing (hybrids to wet polish)



BB Series



SR Series



FP Series



REP Series

Grinding & Polishing (dual purpose series)



Fenix Series

Overlays & Concrete



DX Series

Natural Stone (Dry Polishing) & Concrete

HTC has many other diamond tooling series for all types of applications. Click or call to find out more!

¹All HTC Blackline floor grinders come with a 2 year warranty with the exception of the HTC 1500 iXT, which comes with a 1 year warranty.

²One free HTC University training spot will be allotted for each purchase of an HTC 650 HDX, 650 RX, 800 Classic, 800 HDX, 800 RX or 950 RX.

HTC | the innovators not the imitators™



HTC
Professional
Floor Systems

1-877-482-8700

www.htc-floorsystems.com

Award Winning Floor Grinders & Dust Extractors

Coatings Removal • Floor Prep • Grinding • Polishing



HTC 1500 iXT



HTC 950 RX



**HTC 800 RX
(HTC 800 HDX)**



**HTC 650 RX
(HTC 650 HDX)**



**HTC 800
Classic**



HTC 500



HTC 270 EG

	54.3"	36.2"	32"	26"	32"	21"	10.6"
	4,188 lbs	1,323 lbs	1,200 lbs	1000 lbs	706 lbs	310 lbs	230 lbs
	2 x 15 HP	20 HP	20 HP	15 HP	15 HP	5.5 HP	3 HP
	3 x 460v	3 x 460v	3 x 460v	3 x 460v	3 x 460v	1 x 220v	3 x 460v 1 x 220v



HTC 80 iD



HTC GL 40 D



HTC GL 35 D



HTC GL 25 D



HTC GL PS

	476 cfm	300 cfm	240 cfm	200 cfm	N/A
	573 lbs	373 lbs	130 lbs	123 lbs	120 lbs
	11.5 HP	5.5 HP	4.7 HP	3.3 HP	N/A
	3 x 460v	3 x 460v	1 x 220v	1 x 220v 1 x 110v	N/A

The Home of Diamond Wire

One word —“passion”— describes WideCut and its owner, John Han. He has worked his whole life developing diamond tools and most of all professional diamond wires. “The strive to improve the cutting speed more and more is essential, but above that stands safety,” Han says.

That nothing is done by coincidence is rather obvious around WideCut. Even the new plant and office is a meticulous masterpiece that instantly reflects what the company is dealing with. The spacious and futuristic three floors and 16,000 sq ft plant inspires professional diamond wire manufacturing. And that is what WideCut does exclusively, with 100% of the production exported.

Japan dominates

The biggest foreign market is Japan with about a 35% share, followed by Europe with 30%. About 10% of the production is sold to the US, 15% to Asia, and a remaining 10% to other parts of the world.

WideCut has two main product sectors: diamond wire for concrete (90% of the company's production), and diamond wire for stone. Annually about 19,700 ft of diamond wire is produced at the factory with only about 25% of the factory's capacity currently in use. Annual sales are \$4 million with 18 employees.

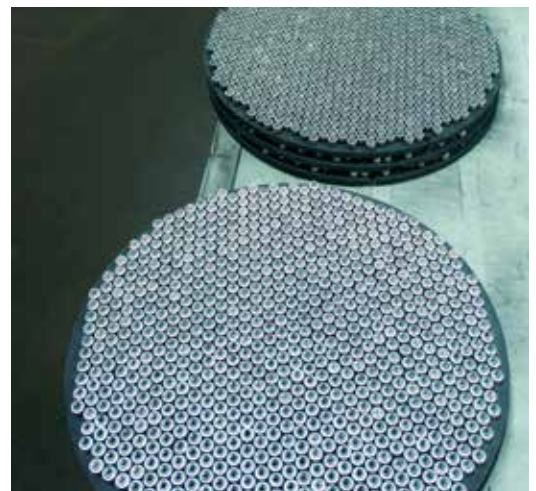

Sintered WideCut beads.

has a vision and a passion carved in stone. He knows what he is doing, where he stands, and where he wants to go.

Originally from the very south of South Korea, Han graduated with a major in Metal Engineering at a University in Korea. In 1985, he joined the Korean diamond tool manufacturer EHWA Diamond and made quite a career, rising to become the head of its research and development department. Han's main task was to develop and produce Korea's first diamond wire.

In 1996 Han was sent to EHWA's U.S. subsidiary, General Tool in California, tasked to set up a professional diamond tool production line. When his mission was completed he decided to embrace his long-time dream and establish his own company.

As diamonds were his passion, he was convinced that diamond tools were a promising product. But at that time, he felt that diamond wire needed more research. Because diamond wire had unstable quality at the time, his aim was to develop his own brand. That led to the founding of WideCut in 1998, focusing solely on diamond wire. Indeed, the company's slogan from Day One has been “Only Wire.”

One-man company

Early on, Han was WideCut's only employee, with only a 2,100 sq ft office, research laboratory, and production area. But the

The new WideCut premises in Korea.

TEXT: JAN HERMANSSON
PHOTO: JAN HERMANSSON
AND WIDECUT



A solid background in diamond tools

John Han is calm and humble. Not a man of big headlines, he

of ires

WideCut has the formula to stay at the cutting edge of the competition, providing their clients with first-class diamond wires.

Right: Part of the WideCut management, from the right John Han, Michelle Kim, Dong-Won Shin and Shelly Han.



John Han overlooking from his office the village where his plant is located.

timing could have been better, as Asia was about to experience a severe economic crisis.

“It was a difficult time, indeed,” Han recalls. “But what was driving me was the fact that I did what I loved to do, and I have always liked challenges. In this case, I wanted to develop the perfect wire.”

After producing his first range of products on some used machines, Han began attending shows in Europe and the U.S. in 2001. By showing his products at exhibitions the number of clients increased slowly as well as the company. That same year, Dong-Won Shin joined WideCut as production manager. Shin is still with the company, and now serves as a key manager. He takes Han’s place when he is not in the office.

the business, and is now marketing manager. Helen, his second daughter, is majoring in business and financing, and the plan is for her to join during 2013. Han’s third child, his son Steve, still has some more years of studying, but will join when he is finished with his education.

Purely export

From the outset, WideCut’s focus has been on export. Not one single meter of diamond wire is sold in Korea.

“Korea is a small country with a large number of diamond tool manufacturers—actually some of the biggest in the world—are Koreans,” says Han. “For us to compete with them, we would have needed a huge domestic sales force and a very strong brand name right from the start. For us it was much easier to focus overseas. And that is what we did and still do.”

WideCut’s products are sold through a worldwide network of 30 distributors, with factory-direct sales when there is no distributor in a particular market.

Han has been working intensively with diamond wire development and production for so long, he is a specialist in this field. “In the beginning this industry knew very little about the potential of diamond wires, how they should be designed and how to produced them,” he says. “There was also no specialized production machinery before we started.”

The deeper Han delved in to development of diamond wire the clearer it became that this was the business for him. Cutting with diamond wire is often the most efficient and environmentally friendly method. But the design of the wire is important in order not to cause it to break. A broken wire could easily be a

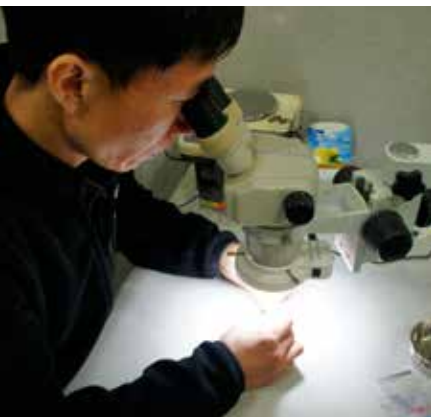

All parts and components are torrowly tested and checked before shipped.



The golden period

Progress continued, enabling the company to relocate to new premises in 2004. This was the beginning of the golden period for WideCut. The company established a good relationship with a partner company in Japan, which soon became the most important market for WideCut products. WideCut’s export business grew significantly to other markets like western and eastern Europe, South Africa, and Americas.

In 2011, WideCut took another important step. Increased production speed was needed to prepare for mass production. Han worked on a new, larger production facility, and built his 16,100 sq ft factory from scratch.

Production was moved into the new factory in July, 2011. At this stage WideCut began the process of becoming a fully family-run company. Han’s first daughter, Shelly, got involved in





John Han has developed and built most of the automated manufacturing machines himself. This particular machine thread the beads automatically on the wire.

Machinery bead setting are also developed by Han.

deadly weapon for the operator or the surroundings.

“A bead on the loose is like a bullet and can penetrate almost anything. It has a speed of 22 meters per second,” Han says.

As there were almost no suppliers of machinery for making diamond wire, Han decided to start developing his own fully automatic production machinery. Today, almost all machinery in the factory designed by Han.

For example, WideCut has 12 different bead process machines, depending on what type of bead is to be produced. The beads has a very high concentration of diamonds. A chain is as strong as its weakest point and it is the same with a diamond wire. If the diamond bead starts spinning, the risk is high that beads start flying around if the wire brakes. That is why all beads are pre-pressed on the wire at WideCut. On a 165 ft long wire there are about 2000 beads.

The rubber that holds the beads on the wire is a key factor for WideCut. The rubber does not only prevent the wire from breaking, it also holds the beads and springs in place in case breakage does occur. WideCut calls it “Black Rubber” and it is developed in close co-operation with a local rubber supplier.

Still, each diamond bead and spring is checked thoroughly at WideCut before an automated machine attaches the components on to the wire. “This is one of many secrets that we cherish deeply,” Han says. “Each of our production methods and the custom-made machinery are patented, and we are very careful with letting outsiders enter our factory.”

About 80% of WidCut’s annual production is sintered diamond wire, used mainly for cutting reinforced concrete. The remainder is electroplated wire used for cutting metal. The manufacturing process for electroplated wire is totally different from sinter wire, as it has a very high concentration of diamond. Han believes that the market for electroplated wire will increase due to the ongoing dismantling of the nuclear industry around the world. In the process industry, the use of diamond wires



The WideCut wire warehouse.

as a demolition method is very common and will grow even more in the near future.

About 70% of the production from WideCut is standard wire and the remainder is for special application. Thanks to the fully automated manufacturing process, wire can be delivered extremely fast from WideCut. They always have about 13,000 ft in stock, and enough to cover demand for one month. Before delivery, all wires are pre-sharpened automatically in two stages. There is even machinery—developed by WideCut, naturally—that blows dust away from the wire after sharpening.

To stay on top of product development and production efficiency is a necessity as competition is fierce. Han says that in three years, the price of diamond wire has decreased 30% and at the same time WideCut has increased the performance of its products by 30%.

But Han with his family and company have found the formula to stay at the cutting edge of the competition, providing his clients with first-class diamond wires <pd>

www.widecut.com



Brazing.



HBR Testing.



Rigorous quality test are made in the WideCut test laboratory continuously.





Ermator



Breathe deeply...



We hope that you have high demands of your work environment. Really high demands. At Ermator, the work environment lead product development. Our air cleaners and dust extractors are therefore equipped with pre-filters and H13 (HEPA) filters, which do a great job with everything from concrete dust to fine gypsum and plaster dust. All so you can breathe deeply, without worrying about hazardous particles.

Our machines also have ergonomic handles and are considerably lighter than their competitors. This is reflected in machines that are kinder to backs and lungs and are adapted to the people that use them every day.

Two of the market's most popular machines, and two of our customers' favourites, can be seen to the left: the air cleaner A2000 and dust extractor S26. Do you want to get a proper feel for them or our other machines? Contact us and we put you in contact with your nearest distributor.

Ermator LLC • 217 Hobbs Street, Suite 107, Tampa, FL 33604
Toll-free: 855-736-2869 • Local: 813-684-7091 • Fax: 813-684-7092



ork
we let
nt. All our
quipped
a superb
rinder
without

d are
s results
and which
day.

d a few
left. Air
want to
? Contact
Ermator

**Tested and Certified
HEPA Filters**



HEPA Filter	Sign
Ermator	
Art no 200600595	
Serie no 080328	
H13/DOP > 99.99% 0.3um	

**Jet Pulse
Filter Cleaning**



**Longopac
Drop-Down Bag**



**Call Us for Additional Product Information
and for the Nearest Ermator Distributor.**

na, FL 33619-8067
ax: 813-685-6782

info@ermatorusa.com
www.ermatorusa.com

ASHINE

Chinas Bright Shining Star

Ashine - the Chinese manufacturer of high quality tools for concrete floor grinding and polishing is set to conquer the world. Here is their story.



Interest

TEXT AND PHOTO:
JAN HERMANSSON

Born in the city of Chongqing, Deng earned a Bachelor's degree on semiconductors in Xiamen University, and a Master's degree on diamond technology in Sichuan University. He decided to make Xiamen his home and, eventually, the headquarters of Ashine Diamond Tools. The company's factory is located about 90 minutes away in Tuzai.

Chinas stone processing district

The area around Xiamen is China's biggest stone processing district, with thousands of small stone processing shops having operated side by side for centuries. So it's appropriate that the area is also home to about a hundred diamond tool manufacturers, as well as many other industries related in some way to stone and concrete processing machinery. Deng is just like any western company leader, determined to put his company Ashine on the international arena. He says that China's development since the 1990s is due in large part to the efforts of former Prime Minister Deng Xiaoping, who opened the country to the world.

"The regime encouraged people to set up their own businesses starting at the end of the 1980s and beginning of the 1990s," Deng says. "I was one of them that welcomed this new strategy and started my company in 1993."

But Deng wasn't alone. Many other private companies started during this period. Names such as Bosun and Antai grew very fast, and quickly dominated the domestic market. Deng's company had only a few employees at the beginning, with a product range limited to traditional diamond tools for stone processing. Along with the fierce competition, Deng also dealt with clients who didn't always pay promptly.

"It could take ages to get paid and no one could survive that way," says Deng.

In 1995, Deng started to focus more on the international market. When a client in Germany asked for diamond cup wheels to grind concrete, Ashine was on its way to becoming a supplier of grinding and polishing tools for concrete floors. The German company has been Ashine's client ever since. Ashine continued to develop and make traditional diamond tools for some years, even

though other Chinese companies began exporting grinding and polishing tools. In 2005, Ashine again adjusted its course, this time focusing entirely on tools for concrete surface preparation, grinding and polishing. The company's fourth generation of polishing tools was released in September 2012.

The Ashine factory in Tuzai has a 32,300 sq ft production area, laboratory, and office. It is almost a completely automated production line with CNC machines. Everything is made in-house, including the resin for the polishing pads, which has a secret and special recipe. Current production is about 100,000 tools a month, but the factory has capacity for double that amount. Most of Ashine's workers live in special housing at the factory organized by the company, a practice common in China. Employees have between 17 to 20 days annual holiday and work eight hours a day, six days a week in two shifts. The minimum salary in China is about \$200 a month. Workers at Ashine have around three times the minimum salary and more. Ashine has a low turnover of people, and most workers have been with the company for 10 years or more.

Because Deng went to college in Xiamen, he remains close to the university and the area's science sector. Today, Ashine is collaborating with three Chinese universities on various projects. Several students have also joined Ashine after graduation.

"Developing polishing pads in particular and creating the typical resin is a very special technology and need years' of development just to make a new generation," Deng says. "We have a very strong internal R&D Team, but the close bond with our universities is very important for our production."

Ashine's R&D centre with a new laboratory is co-established with Sichuan University and Xiamen University which represents the top level of Material Science in China. There is a strong R&D team of scientists, professors and technicians in grinding and polishing technology. And, this team would focus on developing new products and technological innovations, to solve problems from the market and meet different demands of clients.

Very strong foreign market

In 2013 Ashine will celebrate its 20th anniversary. But the last 10



Richard Deng founder and owner of the Chinese diamond tool manufacturer Ashine Diamond Tools represents a young and modern entrepreneurial style in China. He has a strong personal drive with one clear focus in making his company world leader in tools for grinding and polishing concrete floors.



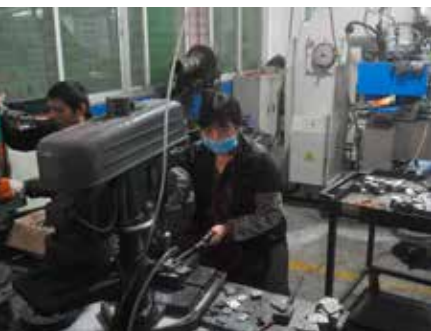

years that have been most essential to the company gaining a foothold in the diamond grinding and polishing industry. Ashine has become a well-known brand all over the world, working mainly with OEMs. About 40% of Ashine's production is exported to Europe and the majority of the tools are delivered to Germany. Another 30% goes to the U.S., while Australia and Japan account for another 10% each. South America, South Africa, and other countries round out the company's export profile.

Of Ashine's 60 employees, eight are in worldwide sales. Products are sold mainly to distributors in each country. The workers are young and have an average age of about 25 to 30 years old. One of the sales managers Cindy Xu, speaks very good English and works with South American market. She has recently been to Brazil, which she believes is a growing market.

"Everything is made by concrete and in particular the floors," Xu says. "It is like China, but Brazil has a bigger potential than China right now. Brazilians are ready to grind and polish concrete floors. It is coming in China too, but it is somewhat rather slowly."

The finished quality of the polished concrete floor varies between markets. Normally the floors are polished in seven steps. Because the U.S. has less demand in the polished level, the floors are polished in five steps, and about 80% of all finished concrete floors are polished with about 800 grit. But in Australia, the demands are much higher in terms of shininess. They polish up to 3000 grit and it is almost same thing in Japan.

"We have seen a great trend in the U.S.," Deng says of his company's largest potential market. "Grinding and polishing of concrete floors is incredibly popular and now almost all supermarkets want to polish their concrete floors, which has given us a great upturn."

The next steps

Deng says that during that last two years China has been considered as having potential for concrete floor grinding.

"There is huge potential in China, but no one understood why there was need to polish concrete floors," he explains. "Now, we're starting to see a change, but there's a long way to go. Still, it's enough for us to hire our first salesman for the Chinese market."

China is the only market where Ashine sells under its own label; it hopes to have some 80% market share in the near future. A group of specialized flooring contractors is gradually emerging. Most of them are rather small, but some have branches all over China. Concrete floor grinding and polishing is becoming an industry in China. "

"But for concrete floor preparation machinery, foreign brands are too expensive for the Chinese contractors," Deng says. "Most of them go for a Chinese copy."

Deng disagrees with the assumption that Ashine's products should be inexpensive, just because they are made in China. "We are not trying to sell low-budget merchandise at all," he says. "We

know that our clients can produce much more with our tools and save labor costs and time. We put a lot of effort and money in developing them. That is why our products are worth more." Deng thinks that very few can compete with the technology that Ashine has developed. His company stays a couple of years ahead in developing products and features, and waits for the right moment to release their new generation.

"We now have our fourth generation of tools and we are working on the next," he says. "One generation is good for about three years. By then, things have developed and the market is ready for an upgrade. Our fourth generation makes the concrete floor much clearer than the previous generation."

Deng offers no hints about what his company's fifth generation of products will bring. But he does express respect for a Swiss competitor.

Still, Deng, adds, "I am convinced that we can offer a more sophisticated technology than most of our competitors. We are determined to be the biggest player in this field in four years. That is our long-term plan."

No doubt, the world is going to see more from Ashine Diamond Tools in the future [cpda](http://www.ashinediamondtools.com)

www.ashinediamondtools.com



Genesis Attachments New Subsea Shear Can Operate at Deep Depths

Genesis Attachments announces its new Subsea Shear, pressure-tested to operate at depths of 10,000ft (3km) for demanding offshore applications.

Available with 32in or 46in (812m or 1169mm) jaw openings, the Subsea Shear features anti-corrosion primer and paint for supreme protection in harsh marine applications—offshore platform decommissioning, pipeline and piling cutting, and underwater steel cutting. Multi-position rigging further enhances the Subsea Shear's versatility as a platform decommissioning shear and

underwater hydraulic shear, enabling it to be cable-hung and operated by a subsea power pack, or from surface power.

"To design a shear capable of withstanding deep-depth pressure and corrosive salt water," says David Palvere, Genesis director of business development, "we started with some of the key features of the industry-leading Genesis XP Mobile Shear, then added offshore application specifics such as Xylan™ anti-corrosion coated fasteners, zinc anodes, and holes along the top and bottom of the shear body for easy



water drainage."

The Genesis Subsea Shear also features a heavy-duty pivot design protected by an anti-corrosion coating for structural strength and long-term durability, and sealed, greaseable pivot points.

Xylan™ is a registered trademark of Whitford Corporation.

www.genesisattachments.com

Marathon and Rhino Tools Land in the Americas

With great commitment and nearly two decades of experience manufacturing industrial diamond tools in Europe, the Spanish companies Marathon Diamond Tools, S.L. and Rhino Tools, S.L. have decided to look to the other side of the Atlantic with a clear aim: to establish a network of regional distributors who will help share their experience with the Latin American market, and offer technical and commercial solutions in both standard and special products.

This endeavor will mainly cover distribution companies and, through them, contractors and industrial diamond tool user companies in Central and South America.

"We want to explore business opportunities offered by several countries in the area with emerging and booming economies," explain Jorge Núñez and Stuart Wilson, managing directors of the group.

From an historical and commercial point of view, both agree that the Spanish-speaking markets in the Americas have traditionally been very receptive to the link with Spain.

"Centuries of common history, a

shared language and culture join us; in this sense a part of the road is made," they add.

Their first stop will be the Republic of Panama, "a brother country that is experiencing a significant growth with exciting projects both in the field of



both companies will offer customers all their resources and experience, while facing these difficult times in the general building market with confidence.

civil engineering and private construction. It also offers great economic and legal guarantees at present," Núñez and Wilson point out.

They define this project as "an opportunity, an honor and a huge commitment" to the Latin American market. Therefore



SCANMASKIN

MACHINES—MINERALS—KNOW—HOW



Removal work and floor preparation with Scan Combiflex 500PD



Scan Combifloor - polished concrete with Scan Combiflex 1000RC



Grinding wooden floors and parquet flooring with Scanmaskin 18



Grinding of bridges and car park areas with Scan Combiflex 1000RC

Scanmaskin Sweden
(Head Office)
Box 187
SE-437 22 Lindome/Göteborg
Phone: +46 31 99 40 70
Fax: +46 31 99 48 70
E-mail: info@scanmaskin.se

Scanmaskin Finland
Raudolittajantie 3 A
FIN-06450 Porvoo / Borgå
Phone: +358 10 292 4700
Fax: +358 19 57 55 002
E-mail: info@scanmaskin.fi

Scanmaskin Denmark
Torvegade 22
DK-7330 Brande
Phone: +45 97 18 00 58
Fax: +45 97 18 45 58
E-mail: info@scanmineral.dk

Scanmaskin Norway
Tomtveien 12
N-2015 Leirsund
Postboks 6, Furuset
N-1001 Oslo
Phone: +47 63 87 60 00
Fax: +47 60 87 60 01
E-mail: info@scanmaskin.no

Scanmaskin USA
1407 132nd Avenue NE, Suite 8
Bellevue, Washington, 98005
Phone: +1 425 628 1212
E-mail: info@scanmaskin.com



Scan Combiflex

a new way of thinking

Contact us for more information

www.scanmaskin.com



New Demolition Power from Finland

Avant Tecno, the Finnish manufacturer of compact multi purpose loaders has unveiled the Avant Robot 185, the first model in its new line of demolition robots.

The electric-driven machine can be powered by a 32A 1.36hp (1kW) or a 63A, 25hp (18.5kW) motor, allowing flexibility and power when and where it is needed. Equipped with a telescopic boom, the Avant Robot 185 has a vertical reach is 18ft (5.5m), and reach is 14.7ft (4.5m). Excluding attachments, the robot weighs 2t.

The Avant Robot 185's hydraulics and electronics have been placed on the lower carriage, allowing a lower centre of gravity providing safe and stable working conditions. The robot is easy and flexible to operate with its continuous 360° rotation and 1.5ft (460mm) telescopic boom extension. The machine is equipped with an EPEC computer and user interface. The remote controls can be used with both radio and cable.

When the space is limited, the upper carriage can be removed while the tracks can be operated separately, resulting in a transport height of 750mm. Standard transport measurements are 5ft (1.55m) height, 2.6ft (795mm) wide, and 7.2ft (2.2m) in length.

The Avant Robot 185 can be fitted with several demolition attachments, such as hydraulic breakers, cutter-crush-

ers, and grapples. The recommended maximum weight of attachments is 606lb (275kg). The robot is designed to work with Avant B220 hydraulic breaker, boosted by the highest impact rate (1900blows/min) in its range.

www.avanttecno.com



Construction Unemployment Drops to 10.8 Percent, Lowest May Mark In Five Years as Industry Add Job And Hours for the Month and Year Over Year

Construction Employers Add 7,000 Jobs between April and May 2013, 189,000 since May 2012; More People Working in Construction since August 2009; Potential for Worker Shortages Grows, Officials Caution.

Construction employment increased by 7,000 in May, helping to push the industry's unemployment rate down to the lowest May level in five years, according to an analysis of new government data by the Associated General Contractors of America. Association officials said the relatively positive jobs report for the sector underscores the need to address potential shortages of skilled workers.

"Although the monthly job gain in May was modest, both residential and nonresidential construction have been

adding workers at roughly double the rate of the overall economy in the past year," said Ken Simonson, the association's chief economist. "At the same time, formerly unemployed construction workers are finding jobs in other sectors, retiring or going back to school. These conditions may lead abruptly to worker shortages in parts of the industry, such as welders and pipefitters."

Construction employment in May totaled 5,804,000, an increase of 189,000 or 3.4 percent over the past year. Aggregate weekly hours of all new and existing construction employees expanded by 5.2 percent from a year earlier. The unemployment rate for workers who last worked in construction dropped to 10.8 percent from 14.2 percent in May 2012, not seasonally adjusted, and the number of unemployed construction workers shrank over the year by 259,000 to 891,000.

The latest numbers were the best May figures for each series since May 2008, Simonson noted.

Employment expanded in both residential and nonresidential construction in May, Simonson observed. Residential building and specialty trade contractors added 5,500 workers for the month and 94,400 (4.6 percent) over 12 months. Nonresidential building, specialty trade and heavy and civil engineering construction firms grew by 1,700 workers in May and 95,500 (3.7 percent) from a year earlier. In a positive indicator for future construction growth, architectural and engineering services employers added 2.1 percent to their workforces over the year.

Association officials said there was still time to avoid some of the future worker shortages that will come if the industry continues to add jobs over the coming months. They urged education officials to rebuild skills-based, or voca-

tional, educational programs designed to help prepare students for careers in construction and manufacturing. And they urged Congress and the administration to reject the arbitrary caps on construction workers that are currently included in proposed immigration legislation.

"Just as contractors found ways to cope with the downturn, we need to make sure we are able to address the challenges that will come with the sector's eventual recovery," said Stephen E. Sandherr, the association's chief executive officer. "One of the biggest challenges this industry faces is limited supply of skilled construction workers available to meet the kind of demand we all hope the industry will soon experience."

www.agc.org

Source: AGC of America, 2300 Wilson Boulevard, Suite 400, Arlington, VA 22201, USA.

Diamond
Core Drills

WEKA

presents:

Diamond
Wall Saws

New Automatic Feed BA 50



powerful up to 500 mm Ø
simple handling
simple assembling
intelligent electronic
completely integrated in SR-machine
no additional casing and cable

New Disc Saw TS 40



at 230 Volt 3,7 kW nominal power
at 400 Volt 6,5 kW nominal power
Bypass for dry cutting
water-cooled HF-motor
adjustable handle
spindle locking device
low weight of 9,5 kg

WEKA Elektrowerkzeuge

Auf der Höhe 20, 75387 Neubulach/Germany

Telephone: +49 7053 96816-0 | Telefax: +49 7053 3138

www.weka-elektrowerkzeuge.de | weka@weka-elektrowerkzeuge.de

The cutting work for removal of the slabs is performed with two FS 9900.

The structural repair and restoration work on Pier No. 2 in Inhaúma, Rio de Janeiro, involved the demolition of 62,430ft² (5,800m²) of concrete over a 90-day period. The work to remove the slabs required a powerful and fast cutting machine as the critical point was to finalize the job in the relatively short span.

Brazilian concrete cutting firm Ekiye-C was looking for a machine that could cut 20in (50cm) deep, as each 26ft x 10.5ft (8m x 3.2m) slab varied in thickness from 12in to 20in (30cm to 50cm). The company chose to acquire two Husqvarna FS9900 saws, due to the machine's power and ability to cut as deep as 24in (62cm) when using a 5ft (1,500mm) blade.

Fast cutting

Another reason for the choice was the assurance that



Husqvarna could provide expedited service in case a problem arose during the job.

The contractor used diamond blades with diameters ranging from 2.6ft (800mm) to start the cut, up to 4.5ft (1,400mm). According to Ekiye-C engineer Federico del Villar, the two 2,100lb (955kg) floor saws cut at a rate of 66ft (20m) per hour, which streamlined the process of removing the platforms.

The , they could cope with the deadline and they were very satisfied with the machine behavior. After the job was finished, the Rio team sent the machines to Husqvarna service center in Cajamar, SP, for a preventive maintenance. They will be then ready for the next heavy-duty job.

For the Brazil market, Husqvarna offers two high powered diesel saws: the FS9900 and FS6600. The FS9900 has a John Deere 99hp (kW) diesel engine and cuts up to 24in (62cm) deep. The smaller FS6600 carries a 66hp (kW) John Deere diesel engine, and cuts up to 16in (40cm).

www.husqvarnacp.com



Cutting with FS 9900 was quite efficient — as much 66ft (20m) per hour.

Restoring a in Rio de Ja

Port Dock aneiro

Top view of the removal of 62,430ft² (5,800m²) of slabs that Ekiye-C performs work on the docks in Inhaúma.

Show 'Em How

Every month or so, the back end of Runyon Surface Prep's expansive warehouse in Carmel, Ind., turns into a classroom. Amid ceiling-high storage racks of equipment and supplies, a few dozen "students"—typically, contractors and facility maintenance supervisors from around the county—spend a couple of days learning the many facets of concrete floor grinding and polishing, often doing much of the work themselves.

TEXT BY JIM PARSONS
PHOTOS BY RUNYON



Though the content varies from class to class, which participants receive at no cost aside their own travel expenses, the overall goal is always the same—help people regardless of age or skill level learn the essential elements of a good floor polishing job, and how to do it the right way.

Over 40 participants

"Better to try things and make mistakes here, than on a job," says Brandon Godbey, who oversees sales for Runyon Surface Prep's national accounts. The December 2012 session added a new dimension to the program's educational mission—manufacturer representatives who assisted with the demonstrations, and discussed the optimal use of their products.

Equipment participants included HTC, Husqvarna, and STI grinders and polishers; Ermator vacuum and dust control systems; and Clarke. Also on hand were CTS Rapid Set concrete, 3M floor finishing and protection products, Metzger/McGuire joint filling and repair products, and Ameripolish color systems.

Drawing more than 40 participants from addresses as diverse as Owensville, Ohio, to Woodenville, Wash., the session combined traditional classroom-style talks with step-by-step, hands-on instruction in the process of taking slabs of fast-setting TRUTM concrete from initial pour to finished perfection.

"This program has come a long way," observed Dick Risch, Midwestern Regional Director for Metzger/McGuire, who has worked with Runyon to conduct several training sessions. "It started as a few guys standing around a garage. Now, we're a school."

The power of knowledge

Launched in 2008, the training program shifted into a higher gear in 2010 after Runyon Surface Prep was spun off by its parent company, longtime Indianapolis-area supplier Runyon Equipment Rental, Inc. Currently serving customers in more than 28 states with full-service equipment sales and rentals,



Runyon Surface Prep is using the training schedule as a key component of ambition to become a true "one-stop shop" of expertise for concrete floor care, a strategy that will also include design services and other types of consultation assistance. Godbey notes that Runyon's training efforts are also designed to address the growing demand for polished and dyed surfaces, particularly when it comes to meeting customers' exacting expectations for appearance and quality.

"Polished concrete is here to stay, so contractors need to gain expertise in working with it so they can make more money," he says. As such, Runyon's training is specifically designed to offer something for everyone. December's students included Gordon Wilson, a former general contractor from the Cleveland, Ohio, area, who recently joined a company that focuses solely on surface prep.

"Being to this industry, I wanted to make the most of this opportunity," he says. "And so far, I've learned a lot."

Veteran contractors benefit as well from the December session. Watching the polishing process at the December session, Mike White of White Industrial Services, Lowell, Mich., recalled a recent project that was rife with mistakes.

"That's a good way to lose a customer," he says. "I decided at the last-minute to come down here, but I'm glad I did. You can never know too much about this business."

Contractors aren't the only audience for Runyon's training efforts. The company also seeks to educate the facility owners and other end-users who invest in the concrete floors, and hire contractors to construct and care for them.

At a recent training session, for example, several non-contractors were invited to take the controls of a polishing machine.

"They thought it would be easy at first," Godbey says with a chuckle, "but they quickly saw just how much time, effort, and expertise are required to do a quality floor. Yes, end-users want things done cost-effectively, but they also want them done right. And I think this group left with a greater understanding and appreciation of what that entails."

So though a participant may experience some "tough



It's Done



love" after making a mistake in a Runyon training session, the value of the lesson learned is more than worth it in the long run "Everyone benefits," Godbey says. "End-users can set reasonable expectations about their projects, and contractors can better answer their questions. It's an ideal, 'win-win' outcome."

Supplying equipment and expertise

Runyon's manufacturing partners agree that they too gain from the experience of contributing in-person, hands-on training.

"It's always better do something hands-on with customers," says Gary Vidal of Ameripolish. "They're actually learning about the product, not just looking at it. And it's a big help to have both experienced people and beginners together."

The hands-on environment also helped defuse any issues with equipment manufacturers going "head-to-head" with their competitors.

"It's a friendly competition more than anything else," says Husqvarna's Andy Davis, whose team was also demonstrating the company's PG 820, as well as its GM 3000 grout products and Hiperhard densifiers. "Runyon brings the best of the best here, and we like the exposure and opportunities to interact with customers and colleagues it provides."

"We offer a different type of equipment, so it's no big deal with be with the other guys," agrees STI's Dave Wood, who showed his company's Prep/Master 3030. "The contrac-





tors get to compare our equipment and our tooling with the others, and see our tooling. And having been contractors ourselves, we experienced with running different machines for different types of projects."

The diversity of products on display was also a boon for Ermator's Fredrik Akermark, who called the Runyon December training session a perfect opportunity to show off the company's various dust control systems, such as the T8600 vacuum and C5500 pre-separator.

"Vacs are usually an afterthought when it comes to looking for equipment," Akermark explains. "Customers want to see the grinders and polishers. But at some point, they will realize they need a vac as well. So, the opportunity to show our products working with different types of equipment, and maybe 10 minutes to talk about what we have is important."

Runyon and its partners also want to do more than merely help contractors learn about the latest equipment. They also hope to cultivate a sense of professionalism among contractors, one that doesn't end after the job is done, and the equipment is packed up.

"A key to growing our industry is to reinforce not only the value of polished concrete, but also what it takes to create and maintain those floors," says Ameripolish president Les Davis. "That leads to repeat customers, and repeat revenue."

And with more training and education, contractors will be better equipped to take surface prep to that proverbial next level, and beyond.

"The industry is doing well," Godbey says, "but we want it to stay well." <pd>



What Else Can Portable Grinding Machines Do?

Portable grinding machine is used for leveling concrete floors in apartments in São Paulo, Brazil.

A new application for the Husqvarna PG 280 was recently developed in the greater Sao Paulo area—leveling concrete floors in new apartments.

Leveling apartment floors

In a partnership between Locadora Orion, a rental company based in São Paulo, and civil works contractor Concima, the floors of recently made apartments in residential buildings are getting leveled to receive the sub-floor or other flooring alternative with the Husqvarna PG280.

Nowadays, civil contractors just prepare the sub-floor in new apartments. They don't sell the apartment with the tiles or other flooring options as they once did. However, it is still important that the concrete floor is delivered flattened to new residents so they can have their flooring option installed as soon as possible.

Contractors usually level the floor either manually with hand grinders or stone grinding machines. In both cases, it's time con-



Narrow and small corridors as well as corners are often one of the challenges to the finish of the floor. But thanks to the smoothness and the design of the Husqvarna PG280 the work in confined space goes very smooth with a good result.



suming and not very comfortable for the operator. What's more, the stone grinding machine is heavy and wide. It doesn't reach confined spaces, disturbing the maneuverability of the machine in the apartments. And because the apartments usually have narrow aisles, using wide machines very often requires the removal of door-posts to finish leveling the floor.

Fast and easy

Husqvarna, through the rental company Locadora Orion, offered the PG280 as the ideal solution for this challenge, given its ergonomic features, low weight (154lb/70 kg), and easy maneuverability. Another advantage of the PG280 is the ability to get close to corners.

Concima was very pleased with this solution. The PG280 improved the work team's efficiency by 70% compared with a stone grinding machine. The total project involves the construction of four towers with eight apartments of 678ft² (63m²) each. During the work the elevators were not operational, so the portability of the PG 280 was a plus, as operators needed to move the machine from one floor to another. That made the light weight of the PG280 critical in keeping the job on schedule.

At press time, the team had ground 15 flats (approximately 10,226ft² (950m²)) with one set of Husqvarna G673D diamond tools. The team expects to grind an additional 7,000 ft² (650m²) using the same tooling

PG280: A New Venture in the Brazilian Rental Market

Husqvarna portable grinder has found new business for rental companies, mainly at the rental chain "Casa do Construtor". In Brazil, some rental companies usually have a locally made stone grinder available for those customers' who need to do some floor grinding. In fact, a floor grinder doesn't appear on the top 15 products rented in the country, and it's estimated that fewer than 5% of the rental stores have this product in their fleet. Does that mean that Brazil holds a big market potential for floor grinders? Based on what has happened in the last two years with the Husqvarna PG280 portable grinder, the answer is most certainly yes.

The market was very receptive to this portable grinder. Being a compact model it became very popular for jobs in small areas where the daily rental is an advantage. Every day, new applications of the PG280 are developed. Floor leveling in apartments, concrete cleaning, stone cleaning, glue removal are just some of the applications that customers are looking for when renting a PG280. They have also realized that the cost/benefit of the diamond tool grinder is better than the traditional stone grinding machine.

Since Husqvarna Brazil started selling this model in 2010, the floor preparation business has been growing in the rental market thanks to the PG280. The most successful case is undoubtedly at Casa do Construtor, one of the top rental stores in Brazil's light construction machinery business. This rental chain has already acquired almost 100 units to different locations.

They have also included the PG280 in the initial recommended fleet for any new franchisee. So each time a new Casa do Construtor store is opened, a Husqvarna PG280 is sold. Currently there are more than 120 Casa do Construtor locations in Brazil. The company plans to have 1,000 stores nationwide by 2020.

Technical Information	PG280
Monophase (V)	220-240
Power (hp/kW)	4/3
Speed (rpm)	1720
Weight (lb/kg)	154lb/70 kg



Floor apartment before grinding with the PG280.



Photos of the apartment after leveling with the Husqvarna PG280.



ICS' Diamond Tools Range



In the US ICS, the world's leader in concrete chain saws and pioneer of diamond chain technology has introduced a new line of diamond blades and core bits under the brand name, ProForce. Developed jointly under a partnership between ICS and Terra Diamond Industries, the ProForce diamond blade and core bit product line combines the resources and expertise of the two companies dedicated to producing, selling, and servicing the highest quality, professional-grade products for professional sawing and drilling contractors.

"At Terra Diamond, producing high-quality, innovative, American made products is our passion. We see this alliance with ICS as a great opportunity to expand our reach with an exceptional sales force and a company that represents the same high standards we believe in," said Terra Diamond president Judy O'Day.

ProForce diamond blades and core bits represent a new standard for performance and reliability and have been tailored for the needs of high production cutting operations.

"We are very excited to

partner with Terra Diamond and bring together the expertise of two industry pioneers who have focused on satisfying the needs of concrete cutters worldwide for over 30 years. Together, we bring an extensive track record of innovative products and customer focused sales and support to serve the challenges of today's market and ensure our customers are equipped to handle all of their concrete cutting applications. We know we have a winning combination and a great product for our customers," said ICS president Dave Gillrie.

Engineered and produced in the US and sold and serviced by ICS in North America, the new line of blades and core bits will be represented by the ICS sales force in the US and Canada.

ICS, based in Portland, Oregon, is a division of Blount International a diversified manufacturing company with global distribution. ICS introduced the world's first concrete chain saw in 1992 and sells a large line of concrete cutting chain saws, diamond chains, and related products through a worldwide distribution network.

www.icbestway.com



ASHINE

Your Grinding Expert

Surface Preparation and Concrete Polishing

Longer lifetime (20000-50000 sq ft.)

Better shine (90-95 degree)

Ashine Diamond Tools Co.,Ltd.

12C 88 Xiangyu Road Xiamen Fujian China

Tel: 0086 592 5688111/112/113

Fax: 0086 592 5688000

email: ashinetools@ashinetools.com

web: www.ashinediamondtools.com





From Spain to the World, Sima Sets Itself Apart

Spain may not be the first country that comes to mind to someone in the Americas when thinking about the manufacturers of construction equipment. But it's home to one of the world's most flexible and innovative companies in the industry today—Sima SA of Granada, Spain.

Power for globalization

Founded in 1970, Sima has enjoyed continuous growth at home and across Europe. Sixty-five percent of Sima's business is outside Spain, and products can be found in more than 45 countries around the world.

"Internationalization has always been one of the main objectives of our company," says Sima President Javier Garcia Marina, son of company founder Antonio Garcia. "We have sufficient machinery, technology, personnel, and production capacity to supply machines all over the world and not just to the domestic market. Therefore, being present in other markets was not an option for us, but rather both a need and an opportunity to continue to grow."

Three important objectives

To solidify its presence, particularly given the currency-driven economic difficulties across Europe, Sima has put a priority on increasing and strengthening its sales network by setting up a network of sales offices and production centers. One is already operational in Milan, Italy, and another will open in Belo Horizonte, Brazil, this summer. Before the end of the year a production facility will also be start up in Doha, Qatar.

Sima has also extended its distributor network to serve new markets, such as the Sub-Saharan region of Africa, Southeast Asia, the Middle East, and the US. The company has also intensified the use of its online "ClickOnSima" service to provide information, service, and product support as well as e-sales.

The second objective is a new way of thinking when it comes to the design and production of new masonry saws—Sima's core products.

"We have created a whole new way of thinking in terms of our products," Garcia

Marina says. "Our new range of more competitive products offers greater features and added value for our clients and end-users. Our R+D+i department has developed a new concept of products which was launched at SMOPYC, the international trade fair held in Zaragoza, Spain."

The Meccano principle

Many people are familiar with Meccano, the technical toy that has interested children and adults for many years. Sima has followed this concept by creating products that can be easily assembled.

"We call it the Mekano range, but it is also similar to the 'IKEA philosophy,'" says Garcia Marina. "Basically, we have designed our products to be easily assembled by the user. The new product idea has been preceded by an extensive engineering and designing work in order to manufacture the products for an easy set up, which also results in just few parts to be assembled by the distributor or end user. Detailed and easy to read manuals are of course shipped with the products."

Already compact when fully assembled, Sima's products are even smaller when shipped, saving both space and shipping costs. There are almost no welded joints on the machines as most of the components are efficiently engineered and screwed together. As a result, products within the Mekano range very much price competitive.

But there's more to Sima than Mekano. The company also has a wide range of traditional masonry saws, floor saws such the new Trencher 60/70 with a dual-blade setting for parallel cutting, handheld power cutters, concrete power trowels, core drilling systems, rebar processing machines, and several series of professional diamond tools and abrasive discs for cutting metal and other type of materials.

There's a lot more to learn about Sima. And the company is confident that contractors and other prospective buyers will like what they see.

www.simasa.com

Integrated Wallsaw from Pentrunder

The concrete cutting equipment manufacturer Tractive has launched a new spectacular HF wallsaw named Pentrunder RS12 - NTGRA® Integrated wall saw. As with all Pentrunder equipment, the RS12 - NTGRA® is a very compact and lightweight saw with high performance. It delivers an efficient cutting fitting blades

Technical data

Weight:	26 kg
Blade	
Max saw blade Ø:	47.0in/1,200mm
Max cutting depth with max dia blade:	20.3in/515 mm
Max start dia blade	36.4in/925 mm
Power	
Saw blade motor:	High frequency
Cont. output power	18.35hp/13.5 kW
Input voltage:	350-500V, 3-phase
Input frequency:	0- 400 Hz
Minimum fuse:	16A

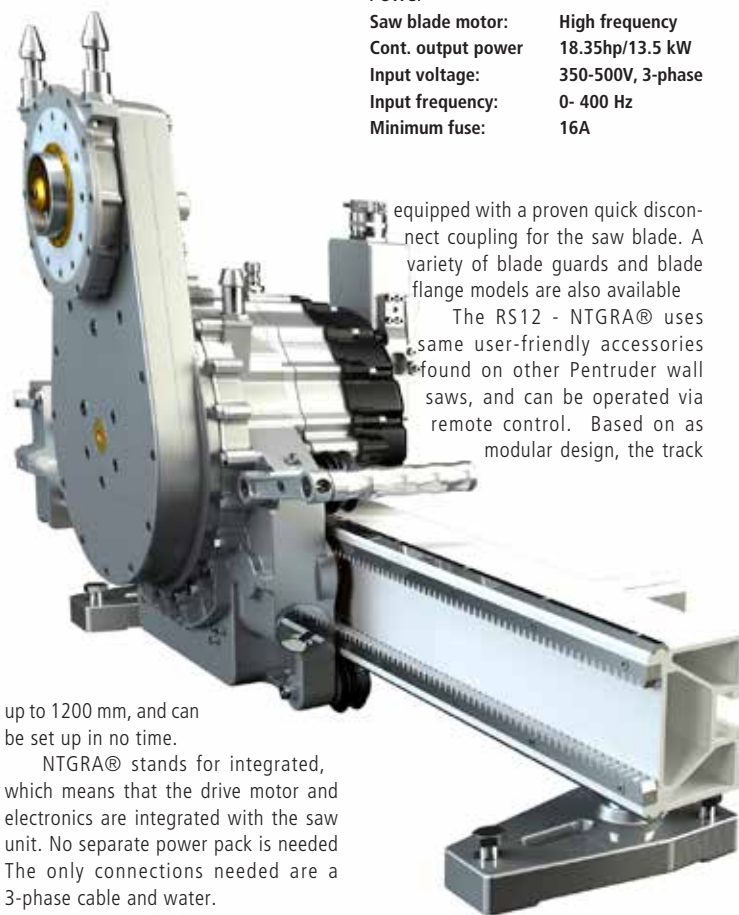

equipped with a proven quick disconnect coupling for the saw blade. A variety of blade guards and blade flange models are also available.

The RS12 - NTGRA® uses same user-friendly accessories found on other Pentrunder wall saws, and can be operated via remote control. Based on a modular design, the track

is up to 1200 mm, and can be set up in no time.

NTGRA® stands for integrated, which means that the drive motor and electronics are integrated with the saw unit. No separate power pack is needed. The only connections needed are a 3-phase cable and water.

The Pentrunder RS12 - NTGRA® is designed and built for maximum reliability, and very easy and smooth service. It has a water cooled motor for high performance and long life, and is

used not only for wall sawing, but also as the drill rig, wire saw rig, and other applications.

www.pentrunder.com



Curators of

From the North-western-most corner of the U.S., Brokk, Inc., aims to broaden the awareness and appeal of remote-controlled demolition machines.

TEXT BY JIM PARSONS
PHOTOS BY BROKK INC.

First time visitors to construction trade shows typically do a double-take when they see a Swedish-built Brokk remote-controlled demolition machine. And no wonder. With its low-profile body, rugged support legs, and three-joint articulated arm clutching a breaker or other demolition tool—all clad in distinctive Brokk yellow—the machine resembles something newly arrived from the future, rather than a product that has been proving itself in challenging demolition environments for nearly four decades.

But while Brokk's eight model line has been developed primarily for niche markets, the features and capabilities are increasingly in synch with the general demolition environment of the 21st Century. And the leaders of Brokk's North American subsidiary want to be sure contractors see the machines as potential solutions, not mere curiosities.

Since the early 1980s

Brokk, Inc., President Lars Lindgren, the fifth employee hired at Brokk AB's main plant in Skelleftea, Sweden, notes that while safety and productivity in difficult environments have always been reasons for considering Brokks since the first machine arrived in the U.S. in the early 1980s to aid with the retiling of New York City's Holland Tunnel, steadily shrinking labor resources have significantly reshaped the construction market in North America, as well as in other parts of the world.

"It's increasingly difficult to find construction workers in general, let alone those willing to operate heavy breakers at odd angles for long periods," he says, citing one contractor who recently detailed three reasons why he was seriously considering buying a new Brokk.

"He could no longer get new workers to run air hammers all day long, his veteran workers simply can't do that kind of work like they used to, and he can't afford all the workman's compensation costs," Lindgren says.

Inside Sales Manager Mike Martin, who first secured North American distribution rights for Brokk machines in 1991, adds that increasingly stringent environmental quality regulations have literally and figuratively shrunk a demolition project's footprint.

"Projects have to be more surgical, and with more debris sorting and recycling," Martin says. "Regulators are closely watching everything demolition contractors are doing."

So too are current and potential customers for demolition services, who now demand the most value from their contractors, regardless of a project's size or complexity.

"Our customers tend to be entrepreneurial," Lindgren says. "Brokks are still specialty machines, but having one allows a contractor to offer services that their competition cannot."

That kind of thinking appears to be on the rise, as 2012 proved to be a record year for Brokk, Inc., with the highest volume and unit sales in company history according to Sales & Marketing Vice President Peter Bigwood.



Sales & Marketing Vice President Peter Bigwood.



f a Concept



“Our customers tend to be entrepreneurial. Brokks are still specialty machines, but having one allows a contractor to offer services that their competition cannot.”

Brokk, Inc. President Lars Lindgren

Picture from left to right: Jonas Pettersson (Service and Training), Julie Rutherford (Accounting), Lars Lindgren (President), Miles Harding (Service), Mike Martin (Inside Sales Manager), David Hall (Logistics), Julie Updyke (Office Manager) and Paul Herrick (Latin America).



tential. In cement plants and nuclear generating facilities, for example, Brokk machines are typically an inherent part of the demolition process.

"It is hard to imagine, today, that a contractor tasked with removing the refractory lining of a 300-foot cement kiln would do the job without a Brokk machine," observes Bigwood.

The same holds true for more conventional settings, particularly where there is limited access, a confined space, or an occupied space, and productivity is important. In addition, many concrete cutting contractors have embraced Brokk machines as a complement to their traditional services, while many shifted their focus to selective demolition as a core part of their business.

"Firms like LVI, NCM, and Penhall have employed fleets of Brokk machines across their organizations," Bigwood says, "but there are many more smaller and mid-sized demolition firms that make the remote-controlled machines the centerpiece of their capabilities."

Penhall Division Manager Scott Galloway says his company has had no problem keeping its four Brokks (two model 250s, a 150, and a 90) busy on projects up and down the West Coast for the past 20 years. Assignments have spanned the renovations of piers, bridge supports, and historic interiors; increasing tunnel height clearances; and demolishing decommissioned bank vaults. In a recent assignment, a model 250 combined with conventional breaking equipment to expedite removal of a flawed foundation slab from a new construction project so that a replacement slab could be poured without interrupting the overall construction schedule.

"Having the Brokk gives you the ability to take on these kinds of projects, and be competitive in areas where we might not be otherwise," Galloway says.

The Brokk machines' precision is also helpful given the highly seismic nature of the West Coast states. Often, Galloway's teams are working in active industrial environments where excessive vibrations can trip earthquake sensors, shutting down the entire facility.

"They're also good when microfracturing is a concern," he adds. "Trimming out an area with a Brokk is better than using a 50- or 60-lb hammer. Try doing that kind of drilling horizontally!"

Brokks can literally be found everywhere. As part of its rehabilitation of the Snoqualmie Falls Hydroelectric System in Washington state, Bozeman, Mont.-based Barnard Construction, Inc., sent two Brokks into one of the world's first underground power plants to help expand a 286-foot deep shaft and create more room for new turbines and other equipment.

"Given the limited space, the Brokks' two-knuckle arm made the touch-up rock and concrete demolition much more convenient than trying to use a small excavator," says Barnard project manager Ely Johnson. "For the really tight space, it was really the only option compared with hand-drilling and blasting."



"Growth came across the board, from virtually every segment the company targets—nuclear, construction, refractory, mining, and process," Bigwood says.

Direct connections

It's fitting that such a unique product's U.S. operations are based in the Pacific Northwest, a region synonymous with innovation and trend-spotting.

Located in Monroe, Wash., just north of Seattle, Brokk, Inc.'s 18,000-sq ft facility houses service and rebuild activities, core equipment and attachments, and parts distribution, as well as office space. Taking advantage of a variety of expedited shipping services, a Brokk part can be delivered on-site virtually anywhere in the Western Hemisphere within a day or two of being requested. The company also operates a service and logistics operation in Stanhope, N.J. where the bulk of the machines come into the country from Sweden.

But unlike other demolition equipment manufacturers, Brokk, Inc., uses a direct sales organization rather than a network of distributors.

"Over the years it has been determined that selling such specialized machines through dealers was not the ideal model, though there are several companies that have established Brokk fleets to support short term rentals," Bigwood explains, adding that a growing direct sales force now covers the U.S. and Canada across multiple industry segments. For Brokk's Latin American markets, Paul Herrick manages a network of national distributors and agents throughout Mexico, Central and South America, and enjoys particular success in the region's mining and process industries.

Limiting the degrees of separation from Brokk, Inc., to its target markets also helps the company stay close to its customers, a convenience that is particularly helpful when it comes to troubleshooting a problem or scoping out an application.

"You call us, and you get instant expertise," Herrick says. "It starts with Lars, who as a former mechanic, knows how Brokks are put together, and extends throughout our organization. Everyone contributes to helping customers understand Brokks, and what they can do."

Some industries are already well aware of a Brokk's po-



HERRAMIENTAS
DIAMANTADAS
PARA LA CONSTRUCCIÓN

BUSCAMOS
DISTRIBUIDORES

TECNOLOGÍA DEL DIAMANTE



APLICADA AL PAVIMENTO



HERRAMIENTAS PROFESIONALES



www.marathondiamond.es
stuart@marathondiamond.es
andrea@marathondiamond.es
Tel: 0034+ 986 37 10 01 - Fax: 0034+ 986 251 991

www.rhinodiamondtools.com
jorge@rhinotools.es
laura@rhinotools.es
Tlfs: 0034+ 986 369 310 - 0034+ 630 883 800

Conjet Equipment Selected for the World's Most Prestigious Concrete Repair Projects

Successful Dam Renovation with Conjet Equipment

- ◆ Conjet Robot 365 MPA provides the required reach and stability
- ◆ Significant time saving with a flexible Multi Purpose Arm
- ◆ Hydrodemolition creates an exceptional bonding with the new concrete overlay, resulting in more durable and longer lasting repairs



A Conjet Robot operated from a platform specially designed by the contractor, with advice from Conjet, to cater for the geometry and slope of a spillway channel at the Guri dam, which have an average slope of 51°.



Turbine repair.



Spillway repair.



www.conjet.com



Your
SUCCESS ★

IS OUR

Legacy ★



Here's to 40 years of big ideas. And 40 more of bigger possibilities.

No annual event is more important than the year's first and the industry's only international show specifically geared to you – the concrete and masonry professional. Above all, WOC gives you a world of opportunities to see cutting-edge products and equipment, connect with peers and establish key relationships that will shape your business and the industry for years to come.



Tackling the learning curve

Still, Brokk, Inc.'s leaders admit that they still grapple with knowledge gaps and misperceptions about their product, and remote control demolition machines in general.

"Our biggest challenge is to help people understand the sheer power that a Brokk machine brings to the party relative to its weight," Bigwood says. "Short of seeing it with your own eyes, it is very difficult to appreciate just how much more capability is built in to the design, compared to traditional excavators or skid steers."

"The best salesman for Brokk," Martin agrees, "is a Brokk."

Interestingly, Brokk may get some assistance in this regard from an unlikely source—competitors. The past few years have seen Husqvarna bring several models of demolition robots to the market. Avant Tecno of Finland rolled out a new machine at the trade show Bauma 2013 crafted by its recently acquired Finnish counterpart Finmac, which also partnered with Stanley LaBounty in a U.S.-oriented venture three years ago. Rumors also persist of a Chinese-built machine.

Bigwood says that on the whole, the arrival of new players in the market does Brokk more good than harm.

"For one, it 'legitimizes' the product category," he says. "We're no longer 'that odd little machine.' Now, we can spend less time convincing people that a demolition robot is a viable option, and spend more time on the nitty-gritty of the application and how we can help them solve the problem."

And while Brokk has always had a strong R&D focus, Lindgren says competition provides some welcome motivation for the company to make good things even better.

"Having other players in place sharpens up our design sensibility and focuses us on bringing new and even better products to market," he says. "We've been doing this for a long time, and while others can emulate our approach in their own designs, they will have a difficult time emulating the valuable lessons that come solely through the experience of testing, development, and application."

At the same time, nobody in Monroe expects Brokks to be a staple of every demolition contractor's tool arsenal.

"Many applications just cry out for a Brokk—we call them 'Brokk Jobs,'" Martin says, "but there are often times where the scope of the job alone doesn't justify the purchase of a machine. Neither does needing a machine maybe a week or two in a year. That's when contractors should look to one of the specialty rental companies for help."

Yet while Brokks may never be fully "mainstream" demolition products, there's little doubt that its niche will only grow in the coming years.



"Health and safety considerations will certainly play a role in the continued growth in popularity of these machines, along with the increased difficulty in finding workers willing to wield jackhammers for a shift," Herrick says. "We are constantly coming across new applications where we are literally replacing two guys swinging sledgehammers. Not only can this be dangerous, it is really not an efficient approach. We see this trend continuing."

And given Brokk's track record for those needs, Bigwood says the company knows what it will take to make the most of those opportunities.

"When you focus on just one main product, you must develop the ability to broaden the machines' capabilities through a wide variety of attachments and a deep understanding of applications," he says. "We are selling more than a machine. We sell a concept—an innovative way to solve vexing construction-related and industrial problems safely and productively. And when we hit the sweet spot, there's nothing better than that!" [\(pda\)](#)



PROFESSIONAL

D

O

DEMOLITION

O

AMERICAS

Your Gateway to North, Central and South America

Digital, Online or Both?

*Get Your Own Copy of PDa By
Registering on www.PDAmericas.com*

US\$20

Online Magazine, 4 Times per Year
Directly to Your Computer:

US\$45

Printed Magazine, 4 Times per Year
Directly to Your Postal Address:

US\$55

Online and Printed Version, 4 Times per Year

www.PDAmericas.com

Our Core is Service

Inhouse Research, Development and Production of:

- Segments and Crowns
- Laser welded core drills in diameter from 8 to 300 mm
- Brazed core drills from 8 to 1500 mm
- Laser welded diamond blades in diameter from 105 to 1200 mm
- Brazed diamond blades from 105 to 2500 mm
- Grooving and special diamond tools



Premium Diamond Tools made in Germany

KERN-DEUDIAM

Diamantwerkzeuge und Maschinen GmbH • Industriestr. 24 • D-33161 Hövelhof
Tel.: +49 (0) 5257-507-0 • Fax: +49 (0) 5257-507-40 • info@kern-deudiam.de

Marathon and Rhino Tools Land in the Americas

"We want to establish a network of regional distributors to share with them our experience"

With great commitment and an eighteen-year-old experience manufacturing industrial diamond tools in Europe, the Spanish companies Marathon Diamond Tools, S.L. and Rhino Tools, S.L. have decided to look to the other side of the Atlantic with a clear aim: to establish in the next months a network of regional distributors to share with them their experience in the American market and to offer technical and commercial solutions in both standard and special products.

This Project will mainly cover distribution companies and, through them, contractors and industrial diamond tool user companies in Central and South America. "We want to explore business opportunities offered by several countries in the area with emerging

and booming economies", explain Jorge Núñez and Stuart Wilson, managing directors of the group. From an historical and commercial point of view, both agree that the Spanish-speaking markets in the Americas have traditionally been very receptive to the link with Spain: "Centuries of common history, a shared language and culture join us; in this sense a part of the road is made".

Their first stop will be the Republic of Panama, where they are going to travel in the next days as a first site contact. "Panama is a brother country that is experiencing a significant growth with exciting projects both in the field of civil engineering and private construction. It also offers great economic and legal guarantees at present", both directors point out.

They define this project as "an opportunity, an honor and a huge commitment" to the American market.

Therefore both companies will offer to the customer all their resources and experience, while facing with optimism these hard times in the general building market.

www.rhinodiamondtools.com

Marathon y Rhino Tools desembarcan en el continente americano

"Queremos establecer una red de distribuidores regionales con los que compartir nuestra experiencia"

Con gran compromiso y una amplia experiencia de dieciocho años fabricando herramientas de diamante industrial en Europa, el grupo de empresas españolas formado por Marathon Diamond Tools, S.L. y Rhino Tools, S.L. ha decidido mirar hacia el otro lado del Atlántico con un objetivo claro: establecer en los próximos meses una red de distribuidores regionales con los que compartir su experiencia en el mercado americano y ofrecerles soluciones específicas para el cliente tanto en producto estándar como en productos especiales.

El proyecto pretende abarcar principalmente a empresas distribuidoras y, a través de ellas, a contratistas y a empresas utilizadoras de herramientas de diamante industrial en el centro y el sur de América. "Queremos explorar las posibilidades de negocio que ofrecen varios países de la zona con economías

emergentes y en franca expansión", explican Jorge Núñez y Stuart Wilson, directores comerciales del grupo. Ambos coinciden en que, desde el punto de vista histórico y comercial, los mercados de habla hispana del continente americano han sido tradicionalmente muy receptivos al vínculo con España: "Nos unen varios siglos de historia común, una lengua y una cultura compartidas; podríamos afirmar que una parte del camino está hecho".

En este sentido, su primera escala será la República de Panamá, país al que viajarán en los próximos días para realizar una primera toma de contacto con empresas del sector. "Panamá es un país hermano que vive un momento de crecimiento significativo con proyectos muy interesantes tanto en el ámbito de la obra civil como en la construcción privada y que ofrece magníficas garantías económicas y jurídicas en el momento actual", puntualizan ambos directores.

Ellos definen este proyecto como "una oportunidad, un honor y un enorme compromiso" con el mercado americano, asegurando que pondrán todos sus recursos, experiencia y capacidad al servicio del cliente, enfrentando con optimismo los tiempos difíciles que atraviesa el sector constructivo en general, y el español en particular.

www.rhinodiamondtools.com

Brazil Continues Its Fast Expansion

Increased consumption has generated the need for major investments in infrastructure to accompany economic growth. There is construction going on everywhere in this big country, in all segments.

TEXT BY LUIZ CARLOS BERALDO

© DREAMSTIME.COM

es sion

The international economic crisis "has not come knocking on the door of Brazilian families," according to Finance Minister Guido Mantega. And after a downturn, the country has enjoyed upward growth despite ending 2012 with modest growth of 0.9% of GDP Gross Domestic Product. It is true that the rate is much lower than what Mantega announced a year earlier, but all forgive the error of prediction. As a representative of the government, after all, he is expected to be optimistic.

A Growing Middle Class

The growth rate of the Brazilian GDP, released in early March, reflects the curious situation the country finds itself in. Amid the turmoil in the world economy, the country has now no choice but to invest in infrastructure to handle the growth of consumption triggered by changes the government has implemented in recent decades. Thus, despite the downturn in the world economy, the country has managed to sustain itself with help of the domestic consumption that handled the economy and allowed the positive result.

This is because the middle class has grown from 38 percent of the population in 2002 to 53 percent in 2012. The lower class has shrunk 27 percent, and the upper class grew by 20 percent. According to studies by the Secretariat of Strategic Affairs (SAE) of the Presidency, Brazil's middle class has grown by 35 million people over the decade, and now stands at 104 million people (53 percent of the total population of 196 million inhabitants).

Brazil is experiencing a contradictory moment in infrastructure. Extremely positive signals from many segments in the industry stimulate the growth of construction works in various sectors. There is a great need for expansion, favorable investment are made in many industry sectors and many of the new projects has government-sponsored financing or supported public and privately. And this is being applied across the country.

On one hand, the investments grew 73.5 percent between 2007 and 2011. A further increase of 17.6 percent is expected this year, following several announcements of billionaires' financial investments concerning the most varied areas of this segment.

On the other hand, the construction works of the Growth Acceleration Program (PAC) completed by June represent only 29.8 percent of the total estimated up to 2014, which is R\$708 billion (US\$335 billion). PAC stands in Portuguese for "Programa de Aceleração do Crescimento" PAC is a major infrastructure program of the Federal government of Brazil. The program was launched on January 28, 2007, by the Lula da Silva administration, consisting of a set of economic policies and investment projects with the objective of accelerating economic growth in Brazil. The program had a budget of \$503.9 billion (US\$238 billion) reais for the 2007-2010 quadriennium. The Rousseff administration has continued the program under the name PAC-2.

Furthermore, the relationship between infrastructure investment and Gross Domestic Product (GDP) has fallen since 2009. For this year, the expectation is to obtain a rate of only 2 percent, which leads Brazil having lower quality infrastructure than countries such as Chile and Colombia.

These numbers are part of the research Major Infrastructure Investments in Brazil, which compiled information about 1,200 primary and secondary sources to present the perspectives of eight sectors of the economy, its major construction works, and financial contributions projected through 2017. Commissioned by Sobratema, Brazilian Association of Technology



PHOTO: LUIZ CARLOS BERALDO

Residential construction: housing was the sector, which sparked the growth of the construction around the country.

for Construction and Mining, the survey encompasses 11,533 construction works whose estimated value is R\$1.68 trillion (US\$0.795 trillion).

The main segments

The segment of the economy that represents the largest share of this investment is oil and gas, with 43 percent. Exploration and Production (E&P) represents 75 percent of the general sum for this sector, which is R\$724 billion. The representativeness of the exploration and production of oil onshore has been dropping since the 90s, reaching 10.7 percent in 2010. Currently, offshore production accounts for 89.3 percent.

The high-speed train (HST) is still a construction work of greater visibility, with a value on the order of R\$33.1 billion (US\$15.76 billion) in the transportation area. The investment for this segment reached R\$397.59 billion (US\$188.27 billion) by 2017, with 30 percent of this amount is allocated to ports and waterways, 26 percent for railways, and 18 percent to highways. The sector is considered strategic for maintaining Brazil's competitiveness, as the quality of logistics network can result in additional costs for the entire supply chain. In 2011, the federal government's investment was only R\$ 12.8 billion (US\$6.03 billion).

The energy sector represents investments of R\$216.61 billion (US\$102.59 billion), with power generation projects accounting for 89 percent of that amount. The projected growth in electricity demand over the next 10 years is 4.5 percent per year, according to an assessment of the Energy Research Company.

The area of sanitation is a major challenge for the country. Only 0.2 percent of GDP is invested in this segment. Therefore, the sewage collection reaches 46.2 percent of the population,



PHOTO: VITO GOGOLA/LIBERTINE MODE

Music, dance and beautiful women is the common picture of Brazil, a country that stands for so much more.



© DREAMSTIME.COM



PHOTOS BY VALTER CAMPANATO / AGENCIA BRAZIL



PHOTO: LUIZ CARLOS BERALDO

and only 37.9 percent of collected sewage receives any treatment. By 2017, this segment should have investments of R\$92.3 billion (US\$43.71 billion), still insufficient to universalize the drainage system and sewage treatment.

The program “Minha Casa Minha Vida” has had the highest rate of construction works of the PAC this year, with R\$129.3 billion (US\$61.26 billion). This amount includes housing and infrastructure building. The investments planned only for the housing infrastructure are going to be R\$9.33 billion (US\$4.36 billion) up to 2017.

The industrial sector should present increase of 8.9 percent in terms of investment in the period 2012-2015 compared with 2007-2010. This percentage is lower than the economic growth of the country in each period, since some Brazilian industrial sectors have been losing competitiveness against foreign competitors and feeling the effects of the international crisis. In the case of construction works of industry research, Sobratema estimates that will be invested R\$182.4 (US\$86.39 billion) billion by 2017.

The sports infrastructure is also contemplated in the investments being made in infrastructure in Brazil until 2017. Arenas, stadiums, and facilities for the 2014 World Cup and 2016 Olympic Games will have a total investment of R\$11.14 billion (US\$5.27 billion). The sector of hotels and resorts, which is being driven by the sporting events, should receive investment of R\$39.3 billion (US\$18.61 billion).

“We do because we need”

“It is not because of major events like the 2014 World Cup and 2016 Olympics that we are investing in improving the quality of life in cities, modernization of transport, sanitation and safety, for example,” says vice president of Sobratema, Eurimilson Daniel. “We are doing this because we need.”

Daniel adds, “and we need because we grew very much internally, and because actually these investments should have been made for decades ago. We’re late now rushing to catch up, in almost all sectors such as roads, airports, ports, sanitation. Airports need to be expanded because of increased demand, with more Brazilians using the air transport. There are a lot of small Brazilian cities that do not have basic sanitation (public water and sewer) and this needs to be resolved quickly.”

Any visitor to scroll Brazil, currently, will certainly come across construction works in its way, either at the airport, on the road, in the city or surrounding area. There is a certain effervescent

economic optimism because of this need to “exit delay,” with symptoms such as increased availability of job opportunities even with GDP at its lowest level of growth since 2009. The diversity of machines in operation everywhere is much higher, compared to other times of great growth.

This can be seen in the volume of equipment called the “yellow line” that includes the machines and equipment used in various construction tasks and mining. In 2007, 10,900 new machines from yellow line were sold in the country. In 2011 the total reached 31,000 units, falling to 30,000 in 2012, according to Sobratema.

“I believe that it is in the range of \$30,000 (US\$14,210) per year and may rise in the coming years,” says Daniel. He notes that the share of imports has decreased; the total was 25 percent in 2010, and dropped to 20 percent in 2012 because the government has encouraged local production, seeking to attract manufacturers to install production facilities in the country.

“Many new manufacturers are coming because the favorable policy and market volumes are attractive and many of them needed a manufacturing base in this region of the planet,” Daniel says.

While a tractor or excavator manufactured in the country can be acquired with funds from BNDES, Banco Nacional de Desenvolvimento Economico e Social with annual interest of 3 percent the same imported equipment can only be financed by other banks at prevailing interest which may vary 15 to 20 percent per year.

BNDES is a federal public financial institution, today the main instrument for long-term financing for investments in all segments of the economy. So it ends up becoming one of the most important tools of the government to put into practice their economic, social and environmental politics.

“Although we’re late, we’re doing the homework,” says the Sobratema’s executive. “There are obstacles, but we keep up when needed.” He is satisfied with the actions that have been taken by governments since before the Partido dos Trabalhadores (Workers’ Partied) took power. “We are on the way, but there is still plenty to do.”

A worrying aspect, he says, is the annual volume of investment in infrastructure in relation to the GDP. Despite the significant amount planned up to 2017, should be only 2 percent this year.



PHOTO: VITO GOGOLA/LIBERTINE-MODE.

Hopefully in the future people in Brazil, that today live in shanty towns, can look forward to proper living conditions. The picture shows a, in Portuguese called, Favela in Rio de Janeiro.

“Our investment capacity is still limited, but tends to improve,” he says. “The solution is already underway, with the search for foreign investors to undertake investment and, sometimes, the operation of facilities as roads and transport,” he adds.

Another point of concern is the delay of achievement of parts the investment. This slowdown has been caused by factors such as rigorous environmental approval process or questions irregularities in contract bidding.

“Unfortunately that’s part of the maturing process by which the country is going through, where everything is much questioned,” Daniel says. “We currently have a strict environmental legislation and live in a country with a democratically organized media with enough power. But I see that these aspects end up being effective because there is a perception that if they are foreign investors, they are acting after fulfilling all legal requirements of the country.”

In addition, Daniel says, “we know we’re late, but we have projects ready and now we are creating conditions for investments occur. The actions the government is taking now will be reflected in the coming years. We should be investing

PHOTO: LUIZ CARLOS BERALDO

4.5 to 5 percent of GDP on infrastructure, not just 2 percent as happens now. But we’ll get there.”

Daniel remembers that just housing triggered an uptick in the country’s construction sector, the other investments in the various segments will generate new growth favorable to all sectors of the economy that interact with construction. “In most cases there is no demolition, but rather, extensions to existing buildings,” he says. “The greatest need now is to expand, grow, giving a voice to higher volumes.”

New paradigm: Brazil in the medium and long term

With the changes recently announced by the government, Daniel believes that new investors will come because, “we are one of the best countries in the world to invest in the medium and long term. This is a new paradigm, because until recently, it was difficult to see a foreigner seeing Brazil more then on a short-term basis. Today, we have strong social and economic foundations, which we believe will follow on this way and likely to improve.”

There is no historical benchmark by which to compare



PHOTOS BY VALTER CAMPANATO / AGENCIA BRAZIL





PHOTOS BY VALTER CAMPANATO / AGENCIA BRAZIL

Brazil's current stage of development, but one can look at the period of military rule, when the country achieved high growth rates. One of the major differences of the present situation is the spread of progress throughout the country.

"Unlike other times, there is no migration of the population, as has happened before, which shows that there is development happening everywhere, in every region of the country," Daniel says. "Nobody needs to seek opportunities elsewhere. There is opportunity for everyone everywhere, because there are investments across the all country." **(pda)**



PHOTO: VITO GOGOLA/LIBERTINE MODE.

Saúde! Two Brazilians enjoying a good meal from the Churrasco and the traditional Brazilian drink Caipirinha as a celebration to the improving economy in the country.



PHOTO: VITO GOGOLA/LIBERTINE MODE.

Above probably the most famous beach in the world, Copacabana in Rio de Janeiro.



PHOTOS BY VALTER CAMPANATO / AGENCIA BRAZIL

"It is not because of major events like the 2014 World Cup and 2016 Olympics that we are investing in improving the quality of life in cities, modernization of transport, sanitation and safety, for example," says vice president of Sobratema, Eurimilson Daniel. "We are doing this because we need."



PHOTOS BY VALTER CAMPANATO / AGENCIA BRAZIL

to the left two pictures (upper and lower) from the construction site of the Belo Monte Dam, one of many energy projects underway in the Brazil.

**DEMCON, The Most Devoted Trade Show for
Concrete Cutting, Concrete Floor Grinding &
Polishing, Demolition; Recycling, Etc.**

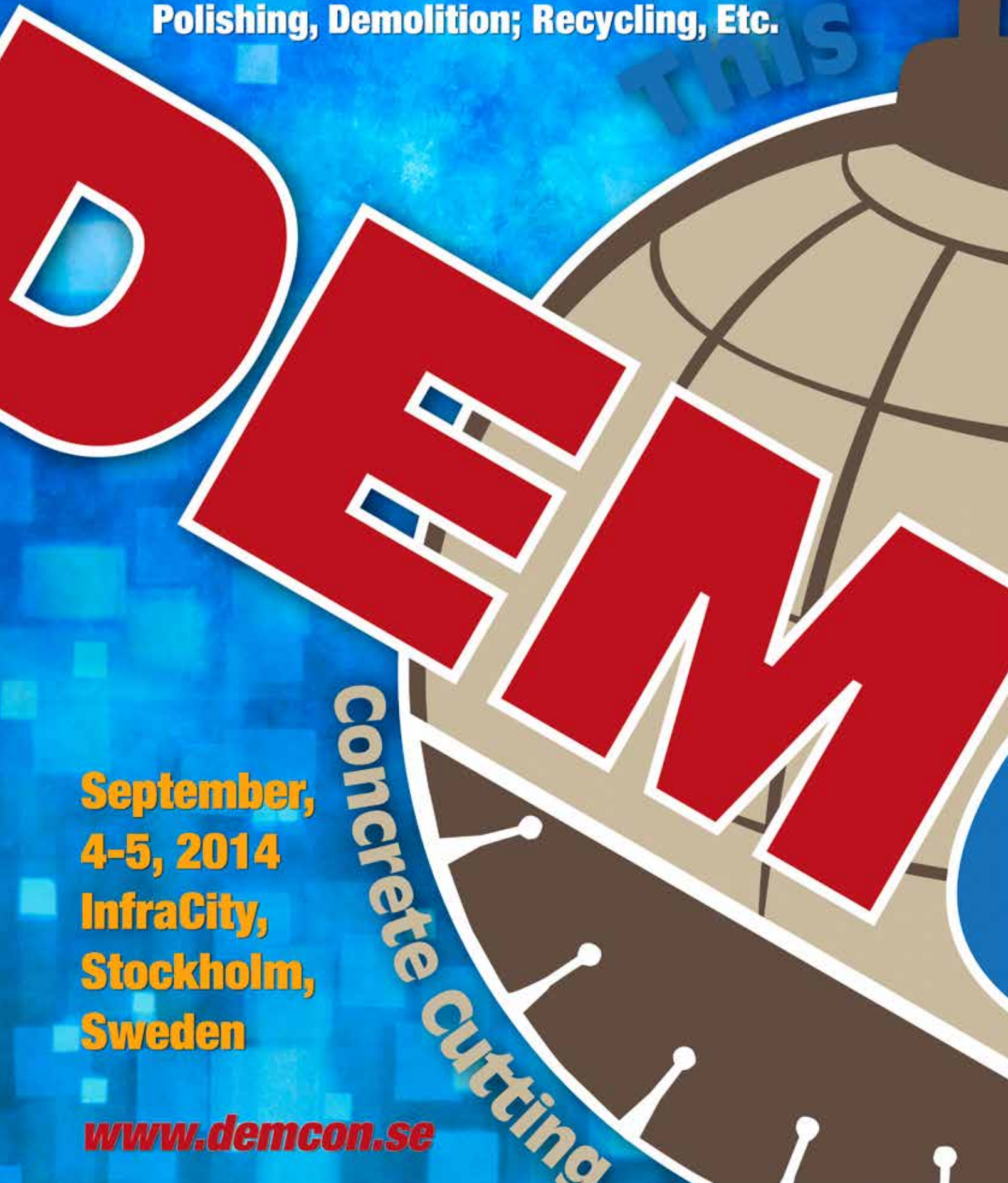

**September,
4-5, 2014
InfraCity,
Stockholm,
Sweden**

www.demcon.se

Concrete Cutting

New Hercules Line of Grinders From Klindex



New "DCS" System - Double Cutting System

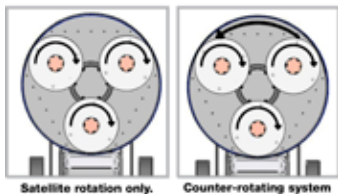

The Hercules series from Klindex is the world's first line of grinding machines to use the innovative DCS "double-cutting" system, combining the features of two quality machines into one.

With the DCS system, Hercules grinders' counter-rotating mode can perform grinding and polishing of concrete, marble, and natural stone floors. The DCS system also increases satellite speed, turning the

Hercules into a high-performance machine for industrial floor preparation machine. The new Hercules series is also suitable for fast removal of resins and glues, exposing aggregates, and leveling very uneven surfaces.

Models are available with 4, 7, 10, and 15hp (2.94, 5.15, 7.35, and 11.0kW) motors, and working widths of 1.5, 1.8, 2.0, and 2.6ft (450, 550, 600, and 800mm) with three size 7.9/9.4in (200/240mm) tools.

The speed of the tools range from 600 to 1300 rpm.

Other features include a strong gear box with thermo-hardened steel gears for longer life, low noise levels, and an auto-leveling planetary system.

www.klindex.it

Genesis Creates a New Dimension in Mobile Demolition Shears

Genesis XT mobile shears, the industry's next-generation shears, are designed to process scrap more efficiently and fit on smaller carriers, reducing both initial acquisition investments and hourly energy consumption costs. Shorter in length and height, and lighter in weight, the Genesis XT series feature a center of gravity that is closer to the excavator, enabling the GXT 555 and GXT 665 models to mount on 23 t to 23t excavators that previously could carry only smaller, less powerful shears.

An improved jaw geometry makes it easier for the XT series to pick up material while also reducing ground-contact wear. The apex, where most cutting is done, is closer to the back of the jaws to improve the XT series' material gathering and increasing cutting performance and efficiency. A reverse-mounted hydraulic cylinder shortens shear length and weight, helping prevent rod damage. Dual-guide blade length matches piercing tip

length, enabling the blades to be shimmed independently to accommodate piercing tip wear.

Other features include a bolt-on piercing tip that encapsulates the upper jaw front, protecting the tang and reducing wear and damage. A weld-on, replaceable, highly abrasion-resistant steel rhino horn protects the front and top of the upper jaw, reducing maintenance and the need for build-up. And, a remote-mounted hydraulic

regeneration valve that produces less hose movement and stress on regen and swivel, extending

hose, re-gen, and swivel life. All Genesis XT shears are covered by a 12-month/1,500-hour warranty.

www.genesisattachments.com

Specifications

Model #	Shear Weight (lbs/kg)	Jaw Opening (in/mm)	Jaw Depth (in/mm)	Typical Reach (ft/m)	Min. Boom-mount (t)	Excavator Reach Stick-mount (t)
GXT555	11,600/5,261	30/762	30/762	8/2.423	45	
GXT555R	13,100/5,942	30/762	30/762	11/3.3	27.5	55
GXT665	13,200/5,987	32/813	32/813	9/2.727	55	
GXT665R	14,700/6,668	32/813	32/813	12/3.6	33	60

Ruwac USA introduces propane powered vacuum

Ruwac USA has introduced the DuoVac 220-S to its Red Line portable vacuum series. The DuoVac takes the vacuum filtration and capacity of the 220V Red Raider and multiplies it by two. It's the perfect unit for tough jobs that require a portable vacuum capable of handling large clean-ups or the point of source extraction of materials, such as dry concrete and cement dust.

Ideal for multiple users, the 220-S includes a quick disconnect cart that transforms the DuoVac into two separate units without the use of tools. For intermittent use, this vacuum has 5.5m² of filter space and a 70mm inlet that allows hoses to extend out to 46m. It's also fully grounded to protect against static build-up and made from a durable compression cast housing that is rust-proof, dent-free and guaranteed by Ruwac for life.

The vacuum's unique foot-actuated drop down dustpan and filter shaker system will not only make cleaning hassle-free, but also add life to the system. A simple shake, step, pull and empty will result in a dust-free clean up alongside prolonged filter life and improved vacuum performance. This vacuum is also equipped with an oversized MicroClean filter that is 99.9% efficient at 0.5 micron for longer vacuum cycles and less filter maintenance. For applications that require absolute filtration, an optional DOP tested and certified HEPA module is available.

www.ruwac.com



New Technology for Floor-Covering Removal

Floor-covering demolition contractors have long had their work cut out for them. Over the years, some new technologies have increased the efficiency of removing tile, hardwood, and other tough floor coverings. However, there are still many applications that require contractors to get on their hands and knees, using a rotary hammer to slowly chip away the covering.

Heavy for the body

For Mark Jones, president of Commercial Tearout Services, and his crew, a large percentage of time was spent on their hands and knees. Understandably, this took a toll on their bodies, as well as the company's efficiency. Eventually, it led Jones to experiment with a new technology to speed up the process and put the hand-held rotary hammer down for his floor-covering removal jobs.

Based in Spokane, Wa., Commercial Tearout Services has been in business for 16 years. Jones and his partner employ two part-time workers. The small company specializes in the removal of non-hazardous floor coverings, which includes basically all materials that don't contain asbestos.

"We remove glue-direct carpet, sheet vinyl, ceramic tile, vinyl composition tile and wood flooring," says Jones. "Occasionally, we remove specialty floor coverings, too."

A device for confined spaces

Like most other demolition contractors, Jones hopes that most of his jobs will allow him to

use an electric-powered ride-on machine that the company owns. The machine is equipped with a front-mounted, two-inch-wide carbide blade, which is designed to quickly knock up tile. However, the unit weighs approximately 2,000lb. Therefore, Jones is limited to using it on slab-on-grade floors and other levels that can be easily reached by elevator. Additionally, the machine is not well-suited to maneuver in small rooms, despite its compact design.

Jones' main frustrations arose from a job at a local Air Force base where he was removing tile from a dormitory floor. "We've been removing tile at the dorm buildings over the last three years," he said. "We've been awarded the contract every year."

Of the five floors in each building, however, only two could be accessed with the ride-on machines. Therefore, Jones and his crew used hand-held rotary hammers to remove tile from the remaining three floors. After taking up the tile with rotary hammers, the team would then run a diamond grinder over the area to flatten the surface. With approximately 4,000ft² (371m²) of tile per building, says Jones, "that's a lot of square footage to do on our hands and knees."

A new solution

One day, Jones heard of a new type of tool carrier on the market, claiming to offer a solution for this problem—the CTS12 from General Equipment Company. The carrier is designed to hold electric-powered breakers rated in the 35lb to 45lb (16kg to



20kg) class, which offer the direct-impulse force needed to break through the bonding material between the floor covering and the surface. The CTS12 bears most of the weight of the electric breaker, taking the burden off the operators and allowing them to work from a comfortable upright position. And, the blow force angle can be easily adjusted to achieve maximum effectiveness.

Jones was able to track down a rental store a couple hours from Spokane that had a CTS12 available for him to use. "The fact I was able to rent one first was a big plus," he says. "A guy doesn't want to spend money on something and find out it isn't going to work."

As hoped, the new solution made a major impact in Jones' operation. "It got everybody off their hands and knees," he says. "It definitely changed the whole game plan."

Indeed, the machine could remove tile at least twice as quickly as hand-held rotary hammers.

"The machine hits so much harder than a rotary hammer and, because of the way the breaker sits in the carriage, the operator doesn't need to manhandle it," he says. "Also, being able to adjust the angle is equally important because the operator works at so many different angles to stay underneath the tile without digging into the slab."

Quick and ergonomic

In addition to working quickly, the machine offered ergonomic advantages to the crew. "It takes a lot of load off your knees and back, so an operator can run it for longer periods of time," said Jones. "And because you're standing up, it keeps your eyes and ears farther from the opera-

tion, instead of having your face 16 inches from the floor."

Because of his success renting the equipment, Jones purchased his own CTS12 in May 2012, along with a Bosch 11335K electric breaker to use with it. Owning a CTS12 has allowed Jones to realize its full potential and understand the best applications for the product.

"We've used it in areas accessible by ride-on equipment, just to see how well it would work on different types of tile," says Jones. "And there are times when the CTS12 is even faster to use than our ride-on equipment."

Even after putting the machine to heavy use on multiple jobs, Jones still experiments with the unit. Besides the airbase, he has used it in a hotel and a local spa, and he's excited to try even more applications. He said, "I'd like to try it on quarry tile, because that's the toughest tile to remove by far."

Despite the benefits Jones has experienced with the new product, it doesn't replace his existing tools. "We still have to use hand-held rotary hammers in tight quarters," he said. "The CTS12 is great in open areas, but it is too long for some small commercial bathrooms and closets."

Nonetheless, for the applications that are well-suited for Jones' CTS12, he is extremely satisfied with the amount of time he has saved and the stress he has alleviated on his crew. In fact, the machine seems to be the perfect complement to the ride-on equipment and hand-held rotary hammers he already owns.

"Every time I've used it, I've prayed because I'm so glad to have it," said Jones. "It makes a big difference."



Hydrodemolition & Jackhammers Go Head-to-Head in Toronto

Although founded in 1999 as a concrete restoration specialist in underground car parking garages using conventional jackhammer techniques Toronto-based CanMar Contracting Ltd. is today taking on its competitors head-to-head using Aquajet hydrodemolition robots. In a garage contract, CanMar was meeting its target of treating up to 1,000ft²/day (93m²/day) of concrete slab using one of its three Aquajet robots. This can be directly compared with a contractor using jackhammers on an identical project in the adjacent apartment block. According to CanMar's Hydrodemolition Manager, David Prociello, a single jackhammer can achieve, at best, up to 50ft²/day (4.6m²/day).

"This means at least 20 operators are required to match the production of the hydrodemolition robot," Prociello says. "Along with being less labor-intensive, hydrodemolition provides a cleaner finish and with less damage."

Leaving sound concrete undamaged

Located on Toronto's Davisville Road, both projects feature identical 30,000ft² (2800m²) basement levels. Built some 40 years ago, the

slabs have since undergone patchwork repairs as remedial treatment against deterioration caused by deicing chemicals on the roads during Canada's harsh winters.

Starting its contract in May last year, and to ensure that the garage could remain operational during the concrete removal, CanMar divided the floors into two phases, each covering half of the two levels. The contract also called for the removal of the 1in (25mm) thick layer of protective asphaltic mastic so as to identify the deteriorated areas. CanMar was then responsible for the selective removal and replacement of concrete over at least 65 percent of each floor to a depth of 4in (10cm) in the 9.8in (25cm) thick slab.

The key element of hydrodemolition was to pressurize and widen existing pores and microcracks in the weakened concrete structure using high-pressure water penetration. Material was easily removed as the build-up pressure exceeds the tensile strength of the damaged or weakened concrete. In addition to the water pressure, the volume of water was also a contributing factor to the systems efficiency. The rate of removal, for example, was dependent on the amount of water directed towards the concrete surface

in order to rapidly and continuously pressurize the areas being treated.

This combination of water pressure and flow together with the controlled kinetic and geometric movements of the robotic equipment created the necessary "effect" criteria for the hydrodemolition process, leaving sound concrete undamaged.

Research into water jet erosion has shown that the concrete resistance against water jet removal is dependent on concrete strength, method of finishing the concrete, aggregate size and the content of steel reinforcement bars. The lower the concrete strength, the larger the material removal rate that can be achieved. This is due to larger penetration and pressurization of the material.

Additionally, the higher the cement matrix strength, the higher the concrete resistance. This is due to the increased difference in the compressive strength of the construction and the penetration effect of the water jets pressure, water volume and jet movement.

Excellent and clean surface

It is proven that hydrodemolition produces an excellent clean surface quality. The pull-off strength, an important indicator of the surface structure conditions, exceeds the required 1.5 MPa (N/mm²) value with a 95 percent reliability. If the surface is prepared with water jets, the interfaced zone between the remaining concrete and the new cast overlay very seldom constitutes a plane of weakness. This compares favorably with a surface prepared with hand-held tools which results in a higher probability on interface failures at pull-off testing. With hydrodemolition, the jet moves rapidly and continuously over the selected area for removal. There is no percussive effect on the surface with the water jet penetrating the deteriorated concrete. Extensive investigations have proved that there is no modification of the concrete microstructure during the water jet treatment. Similarly the

concrete pore structure is not affected by the water jet. Compared with other removal methods, hydrodemolition generates a very large contact surface between the concrete and applied coating system.

Choosing Aquajet

With more than ten years of hydrodemolition experience in both Canada and the US using a variety of US and European marquee robots, CanMar operator Tim Best, considers the Aquajet AQUA CUTTER robot to be the clear market leader.

"It's highly maneuverable and a very compact machine that is able to cut closer to the edges," Best says.

Since making the decision to concentrate in hydrodemolition in 2008, the company has taken delivery of three Aquajet AQUA CUTTER Evolution robots and upgraded an older unit by ordering a 700 hp containerized high pressure PP700 Power Pack. All were ordered through the local distributor for Ontario, Aquachem. Over the past 24 months CanMar has successfully completed more than 600,000ft² (56,000m²) garage slab restoration using its Aquajet Hydrodemolition robots, achieving approximately 150,000ft² (14,000m²) per robot per year—highlighting the success of its newfound niche.



CHECK DUST CONTROL OFF THE "TO-DO" LIST.

SUPER-SIZED SUPPRESSION: Meet the NEW DustBoss® DB-100.



Cover up to 280,000 sq. ft. with a powerful, dust-trapping mist.

DIRECT DRIVE. LOW MAINTENANCE. MAXIMUM EFFECTIVENESS.

DUST BOSS
WWW.DUSTBOSS.COM

Call for details on our risk-free trial!

+1 309 693-8600 x178 | 800 707-2204 (U.S.)

Demolition and Recycling Pavilion at Conexpo-Con/Agg

A new Demolition & Recycling Exhibits Pavilion, showcasing products specific to construction and demolition recyclers and contractors, will feature at the next Conexpo-Con/Agg show in 2014. The pavilion will be sponsored by the Construction Materials Recycling Association.

"Recycling is an important facet of our industries; more demolition contractors are attending the show and this pavilion is one way CMRA serves industry needs," said Conexpo-Con/Agg show director and AEM vice president exhibitions and events Megan Tanel.

Also new, will be the Platinum Lot exhibit area, combined with a reconfigured show footprint and better-defined

product concentration areas. This will make it easier for visitors and exhibitors to connect with the people and companies they want to see. Conexpo-Con/Agg 2014 will also feature a new 'exhibit suites' option as an additional opportunity for targeted interaction between visitors and exhibitors.

"The goal, as with all our planning, is to provide the best trade show value and create the most ROI for visitors' and exhibitors' show experiences. These moves will definitely make a positive difference for 2014; visitors can search less to find what they need and spend more time with exhibitors doing business on the show floor," said Tanel.

The next Conexpo-Con/Agg will be held 4 to 8 March 2014 at the Las Vegas Convention Centre in Las Vegas, USA and is the global gathering place in North

America every three years for the construction and construction materials industries.

Details on Platinum Lot and Exhibit Suites Opportunities

The new Conexpo-Con/Agg show footprint consolidates outdoor exhibition space into three large areas of Gold, Silver and Platinum Lots to provide visitors with improved flow between the indoor and outdoor exhibition areas. Visitors will also find more unified, better defined product concentration areas to help make the most efficient and productive use of their time, coupled with an enhanced internal shuttle system to more easily get from one show area to another. The new Platinum Lot will be across from the South Hall on Swenson Drive and will feature both indoor and outdoor exhibits, the primary registration area, a full service restaurant, one of only two shuttle stops, restrooms and full utility access for show exhibitors. Its major product areas will be asphalt production/paving, aggregates processing and drilling equipment. The Platinum Lot is also anticipated to positively affect visitor traffic flow for the co-located IFPE exposition, in South Hall, since it will be book-ended by major outdoor lots.

Companies may also choose the new Conexpo-Con/Agg exhibit suites option in addition to the show floor as a more personal setting to conduct private meetings, receptions and other visitor focused events. Location is the adjacent Las Vegas Hotel (formerly Hilton) and the nearby Riviera. Participation in the exhibit suites programme is on a first come, first served basis.

www.conexpoconagg.com



New Grinder from New Grind

US company New Grind has introduced a new floor grinder called Rhino. The Rhino is compact, powerful and heavy duty, enabling it to be used in all grinding and polishing situations on all floors. The special tool plates feature magnetic quick release interface, for use with common trapezoid tooling. Customisable tool articulation is achieved by simply choosing between two available densities of replaceable grommets, allowing the Rhino to flatten or conform to any floor profile. The multi point articulating handle feature allows the use of the Rhino in tight areas, which is simply not possible with other machines. Twin high volume stack type vacuum ports, ensures maximum particulate extraction in all situations. The Rhino's unique symmetrical triple pin drive heads yield uniform tool plate articulation.

Rhino weight system

The Rhino at 204kg can be loaded with up to 122kg to increase point pressure for very hard floors and to rapidly

expose aggregate. Biased weight system uses standard Olympic weight plates, allowing placement on either side to increase pressure when grinding edges with slab curl and high and low spots.

Seven reasons

Heavy-duty components from top to bottom ensure the Rhino will take anything you throw at it. Dustless when using 3 Micron Hepa Filter vacuum system. A custom VFD drives the 7kW motor with a choice of single or three phase input power, enables the Rhino to be operated just about anywhere. Heavy duty, extra wide drive belts make for a nearly indestructible, service free drive train. TGS Technology eliminates unwanted corrrows and track marks that are left by other multi head systems. Forward and reverse operation allows for dressing tools without the need to remove them from the Rhino. Most importantly when using the Rhino with hyper gloss grinding and polishing system, time will be reduced by up to 50%.





Conjet Robot Assists with Guri Dam Spillway Repairs

The 10,235MW capacity Guri Hydroelectric Power Station in Venezuela is one of the world's largest hydroelectric power generation schemes. Officially known as Central Hidroeléctrica Simón Bolívar.

Guri went online in 1978, but the original 2,935MW power station was expanded in 1986 to its current capacity, creating a reservoir covering 45,726ft² (4,250km²). The height of the combined concrete gravity and earth embankment dam was raised to 532ft (162m), and the crest length increased to 24,363ft (7,426m). Steel gates on top of the dam's concrete section control overflow from the reservoir down three huge adjacent spillway channels, which have a combined flow capacity of 953,496ft³/s (27,000m³/s).

Surface repair

With the surfaces on parts of the spillway in need of repair, the Venezuelan government's power station owner and operator, Corporación Eléctrica Nacional, awarded a contract for the spillway renovation to the local general and civil

engineering contractor Fapco C.A., based in Puerto Ordaz, Bolívar. The dam spillways have been in operation for more than 30 years and the force of the fast-flowing water, and continuous exposure to sunlight and the environment have combined to erode the surface with caving and loosening of the concrete.

Fapco proposed the hydrodemolition technique using high-pressure water jetting to selectively remove only the weakened and damaged sections of the concrete spillway, leaving a very rough surface for bonding on the fresh concrete. This choice was deemed better than pneumatic breakers, which would leave fractures and microcracking in the concrete to left in place.

Fapco worked closely with Conjet AB and the Swedish company's hydrodemolition proposal was accepted by Corporación Eléctrica Nacional.

"One of Fapco's engineers came to our head office and factory in Sweden to assess our equipment and our suggestion to perform the Guri dam spillway repairs," says Conjet AB executive vice president Lars Göran Nilsson. "We worked closely with Fapco and recommended using a Conjet Robot 364 operating on a purpose-built working platform rolling up and down the steep face of the spillway. Fapco adopted and adapted our suggestion and bought a Robot 364 specifically for the spillway repairs."

Fapco and Conjet also collaborated on developing the Robot 364's operating platform for the geometry and slope of the spillway channels, which have an average slope of 51°. According to Fapco project engineer Yerry Cabrera, "Conjet gave us some preliminary ideas about the access platform, which we then designed and built. The platform was moved by four manually controlled winches mounted

on the crest of the dam. This combination of the platform and robot worked very well."

Concrete removal of up to 69 m² per day

Fapco had to completely repair one channel and perform partial repairs to another, covering a total area of about 80,279ft² (7,500 m²). The Robot 364, operating at water pressures up to 17,404psi (1,200 bar), selectively removed the weakened and damaged concrete from the spillway surfaces to depths ranging from .7in to 6in (20mm to 150mm), and in some instances exposing the steel reinforcement. Concrete removal totalled up to 743ft² (69 m²) each day, and was intermittent due to a combination of moving the platform, adjusting the robot to the spillway geometry and refilling the water tank supplying the Robot 364.

After concrete removal Fapco followed on with a spray-applied 116psi (800kN/m²) strength mortar in areas less than 4in (100mm) deep and 73psi (500kN/m²) strength concrete in the deeper areas.

Fapco started on repairs to the first spillway in late 2009 and completed its contract in May 2011. Work on the project had to stop several times for several months during the rainy seasons, when the spillway channels not under repair had to be opened to control the reservoir level.

"We have had a very good experience with the Conjet robot on the spillway and also used it for some hydrodemolition work on other areas, such as the water intakes of some of the generation units," says Yerry Cabrera. "There is also potential work for repairing another spillway, and possibly some repairs on another dam."

www.conjet.com



Quality Made in Germany for the World



WEKA Electric Tools is located in the south of Germany, in the beautiful Black Forest. Founded in 1988 by Wilhelm Wurster, the company marks its 25th anniversary this year by continuing to develop and produce professional power tools sold worldwide.

WEKA's main products are diamond core drills, which range from .31in to 35in (8mm to 900mm), and in a power range of 2hp to 10hp (1.6kW to 7.5kW). The company's best-known machine is the handheld DK12 diamond core drill, which is used all over the world by professional drilling and sawing companies.

Five hp machines

Besides core drills, WEKA also manufactures hand saws, wall saws, drill rigs, accessories such as water collecting rings, start drilling devices, and other customer-specific electric tools. WEKA is famous for innovative products, such as the five-model line of SR ("switched resistance" motor) machines. This is a very powerful electronic commutated motor for 230V single phase and 400V three phase. For 230V applications, the motor is fitted with a Power Factor Correction (PFC), enabling the motor to supply 5hp (3.7kW), the maximum possible power in the 230V mains. The SR-motor is also available for 400V mains, with maximum power of 10hp (7.5 kW) and a very high nominal torque of 465lbf (630Nm).

The SR25 and SR38 5hp (3.7kW) machines. The SR25 has a single-speed gear box, while the SR38 is fitted with a 3-speed gear. Both machines offer six motor steps; thus the SR38 has totally 18 speeds and thus an extremely wide drilling range. The maximum drilling diameter is 15.7in (400mm).

Ten hp machines

In the 10hp (7.5kW) power range the SR65, SR68 and SR75 are available. Like the SR25, the SR65 has a single speed gear box and six motor steps. The SR68 and SR75 are fitted with a 3-speed gear box. The SR68 has six motor steps and

the SR75's speed range of the motor has been extended to five steps. Together with the three speed gear, the SR75 offers 15 different speeds.

WEKA's SR68 diamond core drill has been specially developed for deep holes on small and medium size drilling diameters, while the SR75 has a very powerful gear and can drill up to 35in (900mm) in diameter. All SR-machines are now fitted with a keypad and display for very easy selecting and indicating the suitable diameter, and an integrated error display and data analysis feature that supports the operator as well as the service technician. The ability to easily read the machine's operating hours is helpful both in servicing the machines, and for rental companies.

Automatic feed

WEKA recently introduced the new BA50 automatic feed, fitted with intelligent electronics that are completely integrated in the SR-machines to eliminate the need for an additional case and cable. The feed is very easy to assemble and handle. With this powerful feed, drilling up to a diameter of 20in (500mm) is possible.

Easy and light dry cutting by hand

Also available is the new TS40 disc saw, fitted with a water-cooled high-frequency motor. The power at 5hp (3.7kW) at 230V, and 9hp (6.5kW) at 400V, all with a low weight of only 21lb (9.4kg). The saw has a bypass for dry cutting, and an adjustable handle, while the spindle is fitted with a locking device for easy assembling of the blade. The TS 40 is driven by a separate frequency converter for 230/400V. For than 20 years, has been represented in the US exclusively by their sales and service partner, Diamond Products in Elyria, Ohio. They stock WEKA core drills as well as spare parts. In addition, Diamond Products is authorized to carry out maintenance and warranty repairs.

www.weka-elektrowerkzeuge.de



New diamond segment grinding systems

General Equipment Company in the US offers the SG24-2300 series as an extension to its line of Diam-A-Tach diamond segment grinding systems.

Designed for a multitude of surface grinding applications, the attachments feature the largest rectangular diamond segments in their class – yet they're offered at a low price point.

The SG24-2300 attachments install easily to popular models of low-speed surface grinders, such as GEC's SG12 and SG24 series. The 30 to 40 grit diamond segments feature Omnitrix single matrix formulation, which gives them a

wider variety of uses than similar competitive products. Popular applications include green concrete, high tensile epoxies, thin film type floor coverings and fully cured concrete.

The segments can be operated wet or dry. Other standard items include extra thick segments and directional markings, which aid in proper installation. In addition to the SG24-2300 Diam-A-Tach series, GEC offers the SG24-2100 series, which comes with round segment pins, rather than rectangular segments.

www.generalequip.com

Conjet's "Nalta" A Power-Packed Concentrate

Conjet is one of the world's biggest manufacturers of remote controlled hydrodemolition equipment. The company was founded in 1990, and today sells machines and equipment all over the world. However the technology dates back to the mid-1980s.

Hydrodemolition is a unique method for removing only the damaged concrete leaving a perfect clean and healthy fresh concrete surface ready for new bonding. Hydrodemolition technology removes damaged concrete using water pressure more than 14,503psi (1,000 bar), for long-lasting, highquality repairs.

A Wide Range

Conjet manufactures three models of remote controlled hydrodemolition robots, available in three different standard models—Conjet Robot 327, Conjet Robot 365 and Conjet Robot 432D. The first two are electrically powered while 432D is diesel-driven. The hydrodemolition system is powered by large diesel engines and high pressure pumps housed in a tailor made container named Conjet Power Packs. The high pressure pumps are available in 360kW to 750kW. The robots can be operated with cable or radio control. In addition to the standard range of robots, Conjet also builds machines according to customers recommendations like for instance an extremely compact robot for hydrodemolition in very confined spaces such as tunnels.

The Conjet Jetframe 114 and the new Conjet Jetframe 101 "Nalta" hydrodemolition systems allow the selective removal of concrete in confined spaces or areas inaccessible to standard Conjet robots. The Jetframes are remotely operated up to 300ft (100m) from the CCU 208 computer control system. The operational parameters can be set and monitored on the display screen on the remote control console.

A unique and small hydrodemolition system

The Nalta Jetframe 101 is quite a revolution. The world's

smallest and lightest hydrodemolition unit, the Nalta (a colloquial expression from Vilhelmina in Lappland in northern Sweden meaning something very small) replaces and robotizes the dangerous and far less-productive handlancing method of hydrodemolition, as the operator remotely controls all functions of the Jetframe 101 at a safe distance from the working area.

The Nalta Jetframe system consists of a feed beam with an oscillating cassette, hydraulic unit, and a remote control box. The oscillating lance, fixed to the cassette, travels along the 3ft (1m) long feed beam, which can also be extended with two extra sections to a maximum length of 10ft (3m). The angle of attack of the lance changes direction when it hits the manually set turning points at each end of the feed beam. This eliminates the need for electric sensors, enabling the unit to be used underwater. Due to the innovative patent protection only one set of hydraulic hoses is required for controlling all functions of the Nalta Jetframe 101, including oscillating of the lance and cassette movements. The Nalta Jetframe is very flexible and versatile as it mounts, climbs, and operates on standard scaffold tubes. There are no electrical sensors, so it can also operate under water. All components are small, light, and easy to carry and position. The cutting head weighs 30lb (14kg), the feed beam section 13lb (6kg), and each hydraulically controlled step units, which are fixed to each end of the feed beam and automatically climb up and down standard scaffold tubes, weigh 20lb (9kg) each. The trolley mounted hydraulic control unit weighs 200lb (90kg).

A number of patented innovations have been incorporated into the Nalta Jetframe 101, which can be quickly and easily integrated for use on standard scaffolding tubes. The Nalta Jetframe is supplied with high-pressure water from a hand lance pump. The operator controls all movements from a handheld portable control box. The Nalta Jetframe can operate on flat as well as curved surfaces with a radius as small as 15.7in (400mm). A trolley-mounted hydraulic



unit that powers the Nalta Jetframe needs only to be connected to a single-phase 10 A, 230 V electrical supply.

Safety has been paramount in the design of the Nalta. Operators do not need the spaceman-type bulky and heavily protective clothing that is vital when using awkward and cumbersome handheld lances. Conjet's Nalta will eliminate the accidents that can occur with the hazardous hand lancing operations and has already proved to be considerably more productive in pre-launch contract trials.

"We are replacing the dangerous hand held lancing operations and making them safer with our new and revolutionary Nalta Jetframe," says Conjet vice president Lars-Göran Nilsson. "Contractors that have used the Nalta have been very impressed with its safety and performance." Nilsson adds that with a hand-lance pump of 120 kW, generating 250N reaction force, "production will be between two to three times higher than

with a hand lance."

Because Nalta can withstand a greater reaction force of 135lb (600N), compared with 56lb (250N) for a hand-held lance, higher-powered pumps can be used, resulting in a five- to six-fold increase in productivity.

"Nalta is also very easy and quick to set up and can work continuously, so there is far less downtime compared to handlancing, where operators have to stop and rest every 20 minutes or so," adds Nilsson. "Hydrodemolition with Nalta is also far more controlled, uniform, and accurate, while selectively removing only damaged concrete. It will prove ideal for those contractors currently using water jetting handlances."

Conjet Nalta is primarily intended for the hydrodemolition of concrete, but is also suitable for other applications, such as surface preparation, paint removal, and the cleaning and de-scaling of steel. An optional power head with a self-driven rotor is available for use in numerous surface preparation tasks. For example, the Nalta Jetframe 101 can achieve HB 2-grade cleaning on steel surfaces when operating at pressures exceeding 36,259psi (2,500bar). The feed beam is attached at each end to a patented hydraulically controlled step-climbing unit. The two-step units fix onto and automatically climb up and down standard scaffold tubes after each traversing pass of the cradle and lance. The step units can also operate on scaffold tubes bent to a minimum radius of 15.7in (400mm), making the versatile Nalta Jetframe ideal for working on curved as well as flat surfaces.

At the recent international trade show Bauma in Munich, Germany, Conjet released a new version of their smallest robot model, Conjet Robot 327, previously called the Robot 324.

www.conjet.com

To the left a picture of the new Conjet Robot 327 which was launched at the Bauma show in Munich.



Blastrac Grinder and Shot Blaster

The Blastrac BHG-1800 is the latest addition to the company's range of handheld machines. Weighing only (5.5kg), this user-friendly 10,000rpm handheld grinder is best suited for surface preparation before coating, grinding, removing or etching of coatings, paint, adhesives, surface leveling, asbestos and much more. The two-position ergonomic



anti-vibration handle makes the Blastrac BHG-1800 grinder suitable for all-day use, and ideal for edges and corners.

Designed for use with the standard 125mm cup wheel, the a heavy-duty, lightweight hand grinder has several optional grinding discs for use on specific applications. Because of its specially designed flexible shroud, the BHG-1800 handheld grinder is dust-free when connected to the appropriate Blastrac dust collection system.

Doosan DL250 Wheel Loader Provides Increased Horsepower and Performance



The upgraded interim Tier 4-compliant (iT4) DL250-3 offers several improvements that enhance its productivity and comfort for moving materials in infrastructure projects, as well as building, site development and livestock production applications.

The 3.7 cu yd (2,2829 liter) DL250-3 has been reintroduced as a 172 hp (126.5 kW) iT4 wheel loader, up from 163 hp (120 kW) in its previous design. It is engineered with a breakout force of 27,120 lbf (36,769 J), a full- turn tipping capacity of 20,680 lb (9,380 kg), and a dump height of 9.1 ft (2.8 m).

For those requiring additional dumping capabilities, the DL250-3 is also available in a high-lift configuration, extending

the dump height by 18 in (457 mm) to 10.7 ft (3.2 m). A new auto-idle feature provides additional noise reduction and fuel savings by reducing the working idle of the wheel loader from 950 rpm to a standby idle setting of 750 rpm when the machine is inactive for a short period of time.

Operators can set upper and lower limits for both the lift arm and bucket stop positions from inside the cab. Better lifting capabilities improve cycle times in digging and loading applications, while providing better control of the lift arm and bucket positions. An optional fourth spool control valve provides operators the capability to utilize an attachment that requires an additional hydraulic function, (e.g., some snowblowers and snow blades).

To keep the wheel loader running at optimal performance in dirty and dusty conditions, the DL250-3 incorporates a new automatic-reversing cooling fan for periodic cooling system cleaning. The fan can be operated manually, or set to automatically reverse on a preset time frame.

As an alternative to the standard limited slip differential, the DL250-3 offers an optional hydraulic locking front differential. Based on ground conditions, the operator can choose to lock the differential manually with a floor-mounted foot switch, or allow the machine to automatically engage the system. This provides increased driving power when one wheel spins or loses traction and improves machine performance when navigating tough terrain.

This Doosan wheel loader is equipped with six-cylinder DL06 diesel engine optimized for use with a cooled exhaust gas recirculation system, a diesel oxidation catalyst, and a diesel particulate filter.

The 360 cu in (5900 cu cm) engine features a high-pressure common-rail (HPCR) design with direct fuel injection, electronic control and four valves per cylinder. The HPCR system's increased pressure allows the injector to inject a finer mist into the engine, resulting in a more efficient combustion that produces more torque and improved fuel economy, less noise, lower operating costs, and cleaner exhaust.

Service intervals on the front lift arms have increased from 50 to 250 hours, reducing operating costs and downtime. Rerouted tilt cylinder hydraulic hoses improve reliability and attachment visibility.

Inside the DL250-3's cab, a number of multi-function display panel upgrades on a centralized monitor allow the operator to view comprehensive machine system information. The centralized monitor also displays critical machine information such as engine rpm and coolant temperature, fuel level, machine warnings, time and the transmission selected gear. Lowered front side glass provides improved visibility, while a new door threshold makes getting in and out of Doosan wheel loaders much easier.

The DL250-3 is covered by an innovative 48-hour parts guarantee. If a "machine-debilitating" part is needed, Doosan will deliver it directly to the end-user within two business days or else pay for a replacement machine rental. The guarantee is subject to carrier delivery restrictions and/or governmental agency delays.

www.doosanequipment.com

Two New Dust Suppression Units from Duztech

Dust suppression manufacturer Duztech has launched the new M and the UF series to complement its already highly successful D series of equipment. The new feature optimizes the size of the microdroplets to suppress construction site dust with minimal wetting by, thereby cutting the need for additional moisture. Having developed a strong foothold across Scandinavia, Duztech is now in the process of building up a dealer network in Europe and the Americas South America.

www.duztech.com



Demarec Debuts New Mobile Rail Cutter

Dutch attachment manufacturer Demarec has introduced the new DRR 30 RC mobile rail cutter for controlled demolition of rail systems, and for scrap preparation of

railway lines. With a cutting force of nearly 900,000lbf (4,000kN), the DRR 30 RC can easily cut all current Vignol flat-bottom rails with a standard quality up to 130,000psi (900N/mm²), and a profile size S7 to UIC 60. The attachment is 7.7ft (2.35m) in length, weighs 2.75t, and has been designed for carriers between 20t and 35t. The rail cutter is also equipped with Demarec's DemaPower System.

www.demarec.nl



Clearing Up

The US construction industry has faced difficult times during the last five years. But at the end of 2011, some positive things started to happen. The second part of the year saw the beginning of a humble, but nevertheless sustained recovery that, according to the latest figures, continued during 2012.

TEXT: DARREN DUNAY

PHOTO: VITO GOGOLA, LIBERTINE MODE

The World of Concrete trade show is a quite good barometer on the US construction industry. A weekend show

in 2010 and 2011 showed increasing number both in exhibiting companies and visitors over the past two events. Still, the US construction industry continues to struggle, due, of course, to the fragile US economy—one that still shows slow employment growth, diminished federal and state funding, and pervasive uncertainty.

Numbers are up in construction

Even though we are well into 2013, the numbers for 2012 are still coming in. But the trends seem to point to positive growth in the national economy and within the construction sector, albeit in varying degrees.

Taking a conservative look at the multi-faceted US construction economy, the McGraw-Hill Construction Dodge Outlook Report predicted that single family housing in 2012 would improve by 10% in dollars, multifamily housing would rise 18% in dollars and 17% in units, con-

tinuing its moderate, upward trend. Commercial building would grow 8%, with warehouses and hotels seeing the largest percentage increases. Gains in office and retail construction, however, would be modest.

The uncertain economic environment would limit growth in healthcare facilities. Manufacturing buildings would increase 4%, following the 35% gain in 2011, as the low value of the U.S. dollar continues to support export growth. Electric utilities will retreat 24%, following a 48% jump in 2011.

The tough fiscal environment for states and localities will cause the institutional building market would slip an additional 2% in 2012, after falling 15% in 2011, with drop-offs in school construction being a key contributor. Similarly, public works construction would drop a further 5%, after a 16% decline in 2011, due to spending cuts and the absence of a multiyear federal transportation bill.



o for Florida

In sum, we can confirm that the US construction industry has developed better than expected. Like the construction sector, however, the growth is uneven, varying from state to state. But one good example of a solid "growth" state is Florida.

Florida ahead

Even if one visits Florida as a tourist solely in search of sun and warm waters, it is impossible not to make note of all the construction going on. Everywhere you look, there are new private houses, commercial buildings, hotels, hospitals, and schools. Likewise, the highways and other transportation network elements have been built-out and upgraded.

If forecasts prove true, this archetypical boom-and-bust state will continue its upward spiral, as jobs tied to the building trades rank among the fastest-growing



*The Sunshine State Could
Portend a Brighter Future for the
U.S. Construction Market*



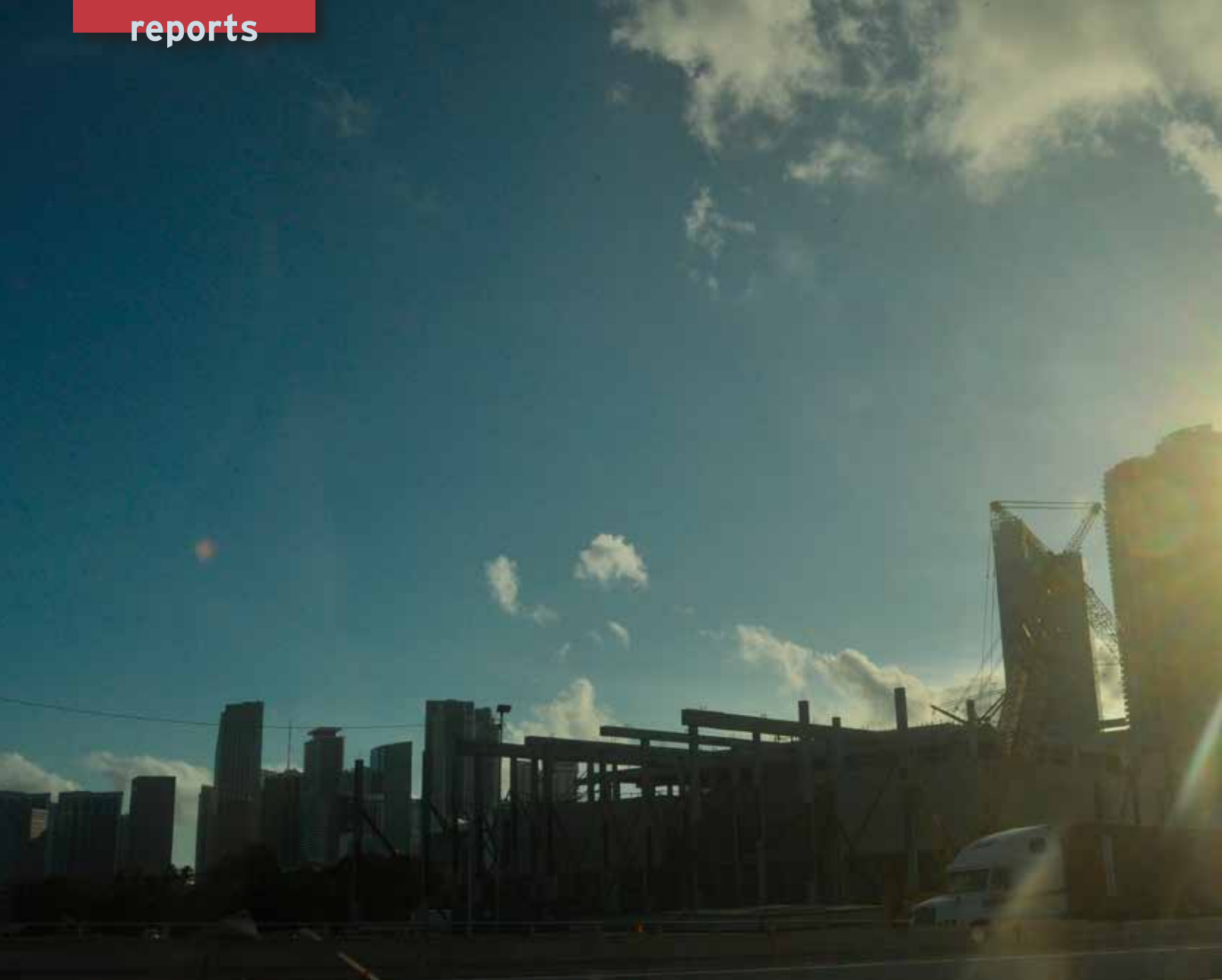

between now and 2019. Government analysts predict that the state's two fastest-growing types of companies over the next eight years will be specialty trade contractors (up 4.1% annually) and building construction (up 3.3%). Three of the five "hot jobs" in that time span are tied to construction and home repair. And according to prognosticators within Florida's Department of Economic Opportunity, the hard-hit construction industry is expected to grow at a 3.6% annual rate this decade, the fastest clip of any sector.

Several factors set the stage for a construction comeback: the foreclosure glut is winding through the courts; home prices have been rising in recent months; and the inventory of available homes has fallen dramatically, from a four-month supply a year ago to just under three months today.

One thing that has a positive effect on the development in Florida is demographics. The state's population is predicted to grow by more than 600,000 over the next three years. It is believed that Florida will overtake New York as the third-largest US state.

Drastic cut backs on the workforce

But it is important to remember that the recession has sliced the workforce from 692,000 to only 307,000 in the



mid of 2012—a 56% decrease. And despite the positive indicators, contractors in Florida are rather reluctant to talk about the growth. Even if construction grows as predicted in the next eight years, the industry will recapture only about 30 percent of the earlier job losses, according to Florida Department of Economic Opportunity. Florida is today struggling with an unemployment rate of 8.6 percent.

Nor does everyone agree on just how much Florida's construction market will grow. The Florida Home Builders Association, for example, is reporting a double-digit increase in sales, while the state's building construction sector is expected to grow with 3.3% during 2013. But many contractors burned by the recession are hesitant about staffing up too quickly so as to avoid overheating.

Still, the work is going to happen. And as the construction sector grows, the need of demolition and concrete cutting services will rise as well. So too will the need for rental equipment. Already, numerous rental machines can be found at work alongside the state's highways.

The trend in Florida is well on its way to spreading to other states. Hopefully, the rest of the US can expect a similarly prosperous construction industry in a few years time [\(pda\)](#)



Hartl Debuts New Bucket Crushers and Screeners



Austrian crushing and screening equipment manufacturer Hartl has debuted an integrated hydraulic jaw crusher/excavator bucket to provide cost-effective, environmentally sound crushing and separation of natural stone and recycling material on site.

The bucket crusher can be mounted on and connected to an excavator or similar machine by means of a quick coupling system. Thanks to the unique Hartl Quattro movement, these crushers deliver a very high average performance rate with minimal wear, and a quality cubical end product with a minimal percentage of oversized material.

The movement of the swing jaw plate is different to conventional crushers, which have a parallel motion. The Hartl system generates an figure-8 motion that allows crushing to begin high up on the jaw face. This also creates a post-crush in the lower section of the crusher chamber.

The result is constant high-quality, cubical material. Independent laboratory tests confirm that the Hartl design combined with the fourfold jaw movement results in up to 30% less flaky end product when compared with double-jaw movement systems.

Hartl products are exported to more



than 65 countries through a dedicated dealer network. The company has also opened an Online Shop offering customers the opportunity to purchase replacement parts, options, and additional products for Hartl equipment 24 hours a day. The Hartl parts finder ensures that customers always locate the correct part, even

if they do not have their maintenance book or spare-parts catalogue at hand. Customers can also track their order and its delivery status online at any time through the Tracking System, and find visual instructions for mounting and servicing their products correctly.

www.hartl-crusher.com

Down to the Wire with Allied Gator's Shear Solution

Uniquely suited to handle hardened steel wire, steel cable and rebar, the patented Allied-Gator MT Series Multi-Tool fitted with the patented quick-change shear jaw set is the only shear design that has proven itself to stand up to continual use in these full-time processing applications.

These materials have been notoriously troublesome for recyclers, and have traditionally been very costly to process with mobile shears.

Thanks to the MT's unrivalled throat force, generated by the patented Allied-Gator power-link and guide system, the tool

can power through each cut with a continual power gain, rather than lose force after these materials have massed themselves into the shear jaw.

In addition, the superior strength and rigidity of the MT's high-alloy steel components allow the tool to shear

through these materials while maintaining the shear blades' stability. This enables the shear jaw set to maintain the blade clearances that are essential to continual cutting performance in these specialized applications.

www.alliedgator.com



MTR 50 S – Cable Processing.



MTR 50 S – Wire Processing.



MTR 50 S – Rebar Processing.



MTR 70 S – Drag Line Cable Processing.

Automized Mist Blankets Dust

Eight heavy-duty dust cannons from Dust Control Technology where serving the, in time very tight, demolition of old structures on the San Francisco Parkway. The parkway could only be closed for 57 hours.

After serving as one of San Francisco's busiest thoroughfares for nearly 80 years, Doyle Drive is undergoing a full transformation into the Presidio Parkway that will include two short tunnels, a wide landscaped median, and engineered transitions to city streets to ease traffic and improve safety.

Following construction of a tunnel and detour roadway to shift traffic completely off of Doyle Drive, demolition of the old concrete structure began in 2012, involving approximately 4,700ft of roadway, including approximately 150 spans in three distinct structures. Yet the plan required that the road be completely closed for just one weekend to demolish its entire length.

Tight Demolition Plan

"There was only a 57-hour window to demolish the existing structure and complete construction of the bypass before we had to reopen the roadway to vehicle traffic," explains California DOT Resident Engineer Andrew Yan. "The structure was divided into four main components, all to be demolished within the same time frame. It was a tall order, but we planned out every detail."

The takedown required a fleet of 40 pieces of demolition equipment, including 20 hydraulic excavators outfitted with a variety of work tools—hammers, grapples, pulverizers, and shears. Crews also used backhoe loaders, track loaders, wheeled loaders, and articulated dump trucks, all running continuously to meet the tight deadline.

Because of its proximity to the Presidio, an historic national park that remained open to the public during demolition, the contract mandated a dust control plan to prevent all visible dust from leaving the project boundaries while work was underway. In some places, says Yan, public areas were less than 100ft (30.5m) away from the demolition activity

"There's also a residential neighborhood and business corridor adjacent to Doyle Drive," he adds. "In addition, we had to consider the nearby marsh, wetlands and forest, as well as the wildlife within those habitats."

With simultaneous demolition in four distinct locations, Caltrans needed a dust control solution that would cover a very wide area, yet require a minimum of manpower and resources. Yan remembered that another CalTrans project faced similar dust suppression issues—the Oakland Bay Bridge West Approach in San Francisco. There, engineers had successfully controlled the demolition dust on that job with large atomized misting units from Dust Control Technology, Peoria, Ill.

After reviewing specifications on the various models

and discussing the project requirements with DCT, Yan arranged a rental of eight DustBoss® DB-60s, with on-site training supplied by the manufacturer.

Dust management by design

One of the best-known designs in DCT's DustBoss product family, the DB-60 is a large-scale suppression unit with special atomizing nozzles that create an "engineered mist," sizing the droplets specifically for optimum dust control (typically 50-200 microns). A powerful 25hp (18.3kW) fan launches the droplets over long distances, allowing one full-oscillation machine to cover nearly 125,000ft² (more than 11,600m²) with a highly efficient dust-trapping mist.

The DB-60 represents one of the few suppression technologies that's effective on both ground level dust and airborne particles. When particle sizes or service environments dictate, DustBoss designs are also engineered to allow a wide range of customizations, including the company's VPS Technology (Variable Particle Sizing). Using a variety of nozzle sizes, shapes, patterns and flow, DCT can tailor the mist output to suit specific dust particle sizes and extreme conditions.

Usually supplied on a wheeled carriage or rugged skid mount, the DB-60's incorporates an optimized fan shape and blade pitch, nozzle components, inlet valves, pumps and filters. A

10hp (7.4kW) booster pump increases water pressure as much as 150psi (10.3bar) from a 2in (51mm) supply hose. Along with adjustable elevation angle range of 0° to 50°, the unit can also be outfitted with a dosing pump to accommodate odor control additives or surfactants to further enhance binding of dust particles.

The DB-60 delivers its power and reliability by using a straightforward, direct-drive fan motor. It has no drive belts, diesel engines or complex gear systems that could present dependability problems in the difficult service environment of a demolition site, coal mine or recycling yard. Despite its size, the machine requires minimal maintenance: lubrication of fan motor bearings is recommended every 10,000 hours, while the oscillation motor is lubricated for life.

Results

With the significant reduction in airborne dust, Yan and his crews contributed to a healthier workplace on the complex Doyle Drive demolition project, while protecting the surrounding communities and natural environment.

"I was particularly impressed by the range of the unit, and the relatively low noise level during operation," Yan says. "The ability to easily mobilize and relocate the units as needed was also a big advantage on this job."

In addition, effective suppression minimized the opportunity for abrasive dust to enter air intakes on heavy equipment, extending air filter life and reducing the potential for unnecessary wear.

"This was a very high-profile job," Yan adds. "Our goal was to take all practical measures, using the best technology available, to mitigate the demolition dust and safeguard people, property and the environment. I would recommend the DustBoss on future contracts of this type."

www.dustboss.com



CalTrans rented eight DustBoss® DB-60s for dust suppression on the Doyle Drive project, with on-site training supplied by the manufacturer.



The Presidio remained open to the public during demolition, so the contract called for a control plan to prevent dust from leaving the project boundaries.



One full-oscillation DB-60 can cover nearly 125,000ft² (more than 11,600m²) with a highly efficient dust-trapping mist.



Demolition of the old structure involved approx. 4,700ft (1.4km) of roadway, including 150 spans, yet the plan allowed complete road closure for just one weekend.



When completed, the new parkway will reveal striking views of the Presidio and San Francisco Bay.



Imagine the scene: a hospital ward, sensitive monitors, hushed sounds, soft lights, calm and confident nursing care, patients recovering from operating procedures. Then, the pneumatic hammering begins and goes on for days on end, penetrating the nervous systems of both patients and staff like a dental drill.

TEXT AND PHOTO: BARBARA GRACE

Hammering and hospitals are not a natural fit. Yet this was the challenge that Jason Franken and his team at Super City Concrete Cutting had to solve as they took up the task of completing the demolition work with no vibration, noise, or interruption to the important work of the hospital or its patients.

Controlled Demolition

In preparing for a new addition at the St John of God

Franken. "High-risk work activities presented challenges around maintaining a safe work environment at all times, so we applied measures to ensure the systems and safety regulations weren't compromised."

As part of this approach, the demolition contractor installed perimeter handrails on the live edge of each work zone. Fitted in a modular format, the railing could be cut and separated, leaving the handrail in place so it was lifted down with the section of concrete being removed. Operators were fitted with a fall-arrest system prior to beginning their sawing and drilling work, allowing them to attach their body harnesses to a certified anchor point, further ensuring their safety while working at height. Once a live edge had been created, another section of handrail was installed and the process repeated throughout the floor levels.

Balancing Safety

Another successful strategy gave the crane driver and banksman a safety buffer by having a free edge for moving the concrete blocks. This provided access to

Removal Sequence

Level 1 and Ground: Isolation perimeter cuts were made using diamond wire saw, track saw and floor saws. Bernie Leen & Sons then used a 40t excavator fitted with a hydraulic concrete cruncher to pulverize the remaining areas to ground level.

Levels 2-3: Support columns, internal and external stair panel walls

Support columns were cut using diamond wire saws with 1no lift hole core drilled through the beam's centre for support. Internal staircases and wall panels were cut using an electric track saw with two 6.8in (175mm) core holes in each section for rigging access.

Levels 2-4: Roof & stair landing

The concrete roof was separated into three lifts with an average lift of 14t. The perimeter roof support beams were sawed using diamond wire in four separate locations. The roof slab was cut using a conventional pavement floor saw to a depth of 15.7in (400mm). Two 6.8in (175mm) core holes were drilled into each section for rigging access of crane chains.

Equipment Used

- Tyrolit SK-B diamond wire saw
- Tyrolit WSE 1217 electric track saw
- Merit 44hp floor saw
- Hilti DD350 core drills
- Tyrolit DME 37 core drills
- Tyrolit BSG 3 diamond wire
- Husqvarna hand and ring saws
- 65kva 3-phase generator
- 100t crane (Williamstown Cranes)
- 40t excavator (Bernie Leen & Sons)
- Freightliner Crane Truck (Super City)



Silent Demolition

Hospital in Geelong, Victoria, four levels of building landings, façade, and staircases needed to be demolished and removed. While this kind of work typically involves traditional hammering and breaking methods, the excessive vibration and noise would have severely impacted four adjacent levels of operating rooms and patient recovery wards. Compounding the project's risk and complexity were height factors and the irregular shape, size, and excessive weight of sections needing removal. This provided an opportunity for the Super City team to work collaboratively with the primary demolition contractor Bernie Leen & Sons to solve these challenging issues using specialized equipment and procedures.

Working Safely on the Edge

"One of our principle concerns involved safety," says

measure the weight of the section and monitor how evenly it would lift once the load was separated from the remaining building.

Each concrete section's irregular shape and size made calculating the centre of balance for each lift challenging, but crucial, so that all concrete sections being lifted remained within the radius and lift capacity of the project's 100t crane. The team estimated the maximum lift capacity of any one section at 16t.

Saving Time and Money

"Separating the concrete sections into large blocks provided considerable benefits to the construction program and budget," says Franken. "By using specialist sawing and drilling systems we completed this part of the demolition project in only eight days."

Because these systems are entirely vibration-free with far less noise than conventional demolition methods, the controlled demolition procedure also allowed the hospital to operate as normal with minimal disruption. The success and productivity of the sawing and drilling systems led to additional work on the hospital project.

"Hospital environments create a number of challenging considerations that we had to consider when pricing and planning the various stages of work," Franken says. "The advantage of specialized sawing and drilling equipment helps us compete more efficiently and competitively, which is very important with the strict parameters hospitals have in place. For them, patient comfort during any construction upgrade is a priority." ■



Demolition in Australia





Brokk Takes J.R. Ramon & Sons to New Heights

Tim Ramon excels in the demolition industry. After all, it's what he has known his entire life. And by drawing on that experience, he's able to provide fresh ideas that are taking his third-generation company to greater heights. J.R. Ramon & Sons opened in San Antonio, Texas, in 1945. To be successful through the roller coaster of economic conditions over the past 67 years, the company found focus to be key. And since its inception, that focus has been demolition.

"Our years of experience provide a solid foundation of knowledge and practical application, allowing us to accurately determine what works best or what method will be most efficient in both typical and unique projects," Ramon said. "We've found the keys to being successful in this industry are ideas. You have to bring fresh and new ideas to the table to help solve problems."

70 year old water tower

It was that commitment to innovation – along with a unique request – that prompted Ramon's team to purchase a Brokk remote-controlled demolition machine.

In 2011, J.R. Ramon & Sons won a bid for the deconstruction of a 70-year-old water tower for the San Antonio Water System. After standing idle for years, the tower was being decommissioned. J.R. Ramon & Sons took on the demolition job – and all the regulations that went with it.

It was, Ramon said, the quintes-

sential Brokk job. "Because of the tower's surroundings and location on an old Air Force base, there were a lot of restrictions on how it could be torn down," he explained. "The water tower was 165 feet [50 m] tall, and we only had a 60 foot [18 m] radius where debris or dust could fall. These specifications made using a Brokk our best and most efficient option."

Ramon purchased a Brokk 180 equipped with a Darda CC420 crusher for the project. The team carefully suspended the Brokk from a crane, strategically positioning it to methodically remove controllable pieces of the tower. As opposed to a wrecking ball or dynamite that would have debris flying everywhere, the Brokk enabled operators to crush the tower, take it down piece by piece and control where the debris fell.

In addition to the crane holding the Brokk, another crane safely held the operator, who was suspended near enough to effectively – and wirelessly – operate the machine. "The Brokk worked great," Ramon said. "This tower was heavily reinforced with very little deterioration, but the Brokk had the power to chew through it without any problems."

The crew began the project in June 2011, and had it completed three months later. In the process, J.R. Ramon & Sons proved that fresh ideas and the right tools can make even seemingly impossible demolition jobs just another part of an honest day's work.

www.brokk.com

Making a Molehill Out of a Mountain



A fleet of 60 Volvo road-building machines is being used to construct a 87-mile (140km) highway across the Andes Mountains—from Bucaramanga, Colombia's eighth largest city, to Cucuta on the border—providing a much-needed high-speed surface link with Venezuela.

Highway on 12,000 ft

This is a staggering project in terms of both length and terrain. Altitudes range from 2,900ft (900m) to 12,000ft (3,600m) above sea level. But Colombian highway contractor MHC is undaunted, due in large part to its reliable fleet of Volvo construction equipment.

Indeed, MHC's president Mario Huertas Cotes has been a supporter of Volvo products since he first purchased six second-hand Volvo 861 haulers in 1982. Though they should now be museum pieces, these same machines from the 1970s have logged more than 60,000 hours—and are still working. "We never get rid of equipment in Colombia," Huertas says with a laugh. "The trick is knowing where best to deploy machines as they age."

In addition to a well-considered attitude to equipment, MHC is adept at handling the sensitive issue of working in remote and potentially dangerous parts of the country where notorious guerilla groups operate.

"Building in a conflict zone is not so difficult," says Mr. Huertas defiantly. "You don't beat these people with bullets, but by providing better social conditions. The areas of Colombia where we operate are often poor, and we provide much-needed jobs and incomes, as well as buying local resources. We are regarded by the guerillas as helping the people and are left alone."

Much safer and faster

Fortunately, the security situation in Colombia has improved to the point where MHC can focus primarily on the challenges of replacing the existing narrow, single-

tracked, and extremely steep road between Bucaramanga and Cucuta with a modern \$400 million highway that will safely support speeds up to 50mph (80kmph), and cut travel time to 2.5 hours—less than half of the current 6-hour slog.

To give a perspective of the task, more than 20 million cubic feet (350,000m³) of earth has to be moved for each mile (1.4km) of road. Stabilizing the road's steep slopes is also crucial, particularly in Colombia's rainy climate where landslides are commonplace. These same slopes put heavy demands on the transmissions of construction equipment, and the high altitude requires adjustment in the treatment of the biodiesel, required for all government construction projects.

In addition, the new road will feature several long-span bridges, including a 2,100ft (40m) structure with columns 262ft (80m) high, making it one of the tallest in the country. There are also more than 3,280ft (1,000m) of tunnels being constructed. At its peak MHC will have up to 1,700 people working at the site.

Fortunately, MHC's venerable Volvo equipment is up to the task. And the company's newer Volvos are protected by customer support agreements. Local Volvo dealer Chaneme provides preventative maintenance, consumables and repairs, all on site.

Mr. Huertas has managed his family company through some of the most difficult times in Colombia's modern history. Now with a full order book and his 28-year-old son, Esteban, working as managing director for the Bucaramanga-Cucuta project, the company is moving into its eighth decade and fourth generation with great optimism. This, combined with sustained economic recovery after years of strife and recession, creates a bright future for South America's second most populous country.

www.volvoce.com

Midwest Demolition Firm Takes Advantage of High-Performance Dust Suppression

Veit Company, one of the most versatile demolition firms in the Midwestern US, has added Dust Control Technology's DustBoss high-performance dust suppression system to its extensive range of capabilities. After renting the equipment on several occasions to gauge its effectiveness under real-world conditions, the company reports far better control of dust-generating activities than the common industry approach of spraying with large hoses, as well as significant labor savings by eliminating manual suppression efforts.

What's more, the new equipment improves workplace safety by allowing employees to position the atomized misting unit closer to danger zones, where the unattended machine can operate without risk of personal injury from heavy equipment or falling debris.

Veit has been a demolition industry leader for more than 80 years, providing complete demolition services, including explosive and interior projects. The firm has successfully executed some of the Midwest's largest and most complex demolition projects— from removing a single house to razing the St. Paul Civic Center, from underwater dredging to commercial diving—while maintaining



Veit reports far better dust control than with manual spraying, as well as significant labor savings.

compliance with all applicable safety and environmental regulations.

Veit also pioneered the art of "surgical removal," with selective demolition and high-risk projects among the company's specialties.

Ryan Olson, Veit's Demolition General Superintendent, says the DustBoss is a great option on both large- and small-scale demolition projects, from 500ft (152m) smokestacks to small ranch houses. "Any job that requires suppressing dust to keep it from migrating off-site or affecting the local environment," Olson adds.

Over the last several years, Olson and his staff have watched regulatory conditions continue to evolve, and they began renting different types of dust suppression equipment to supplement traditional manual spraying on large or sensitive projects. The company tested misting devices from a few suppliers before trying its first DustBoss rental in 2008. After

renting the DustBoss DB-60 for most of June and July in 2012, company officials elected to purchase the unit to make it available full-time.

The unique design of the powerful ducted fan and atomizing nozzles creates a plume containing millions of tiny droplets, primarily in the 50-200 micron size range, which is optimum for dust management in most applications. That plume can be projected more than 200ft (60m) on a calm day, blanketing as much as 280,000ft² (26,000m²) with a single full-oscillation machine.

Depending on the project, demolition equipment used and current wind conditions, Olson's crews will position the DustBoss either to oscillate over a large area, or as a stationary barrier to prevent dust from migrating beyond job site boundaries.

On most projects, the unit is powered by generator, but can also be run from in-house power. Standing just over 7ft

(2m) tall, it's fed by a 1.5in (38mm) hose with came-and-groove quick disconnect for easy coupling to a fire hydrant or other water source.

"For us, there are several benefits," Olson says. "Protecting nearby inhabitants and local environments is key, and the DustBoss is much more effective than other measures we've tried. The labor savings also allows us to concentrate our employees on core activities. It's simple to wheel it into place and aim it, and it works all day. No lunch breaks, no sick days, and it allows us to keep employees further from the demolition work for greater safety."

Olson also reports that the equipment makes an impact on air quality that's readily apparent. "Visually it's easy to see the difference," he says. "We also receive fewer dust-related complaints, and have even received compliments from property owners and city officials who've seen the equipment in action."

www.dustboss.com

Terrco Helps Even the Score for a Power Plant's Floor

A nuclear power plant on the west coast had a problem—a 10,000ft² (929m²) slab that they needed to level in order to erect interlocking pre-fabricated containment buildings that would be used to store spent fuel rods.

Their choices were to remove the entire slab and start over, or try leveling the slab. "That's when I received the call," says Jim Sander, President of the Jim Sander Company.

Sander describes the slabs as one of

the worst he has ever seen. "It looked like an ocean," he says. The slab had puddles of water as much as an inch deep, and a density of 8,000 psi. His crew's job was to remove the high spots and level the floor to .09in (2.4mm) in 10ft (3m).

Sander tackled the project with two Terrco Model 6200 self propelled floor grinders, each weighing 3,000lb (1,361kg), and with a 54in (1.4m) cutting width. These machines were fitted



with 24 pieces each of 4.375in (111mm) diameter 16/20 grit diamonds. Each machine was coupled with a 2,000cfm (56.6m³/m), 14in (356mm) static pressure HEPA vacuum.

"The crew went to work keeping a fine mist on the slab to prevent heat buildup," Sander says. "The weight and

horsepower of each machine bearing down on 24 aggressive diamonds flattened the floor with no problem at 90 degrees, then 45 degrees, then again at 90 degrees to ensure a flatter floor. The floor was refinished to the proper tolerance in four days with a three man crew."

www.terrco.com



On A Roll a Bounty

Bauma, the biggest show in the construction industry, took place in Munich, Germany, at the beginning of April. Manufacturers and users alike eagerly await this triennial event, making it the perfect launch pad for new companies and products. Small wonder, then, that excavator manufacturers tend to gear their launches towards the Munich festival. PDA's Andrei Bushmarin looks at some of the innovations in the heavy-duty sector.

PDa Showcases of New Excavators

The demolition excavator market is well established, so it is small wonder that no new names have emerged since last year. On the contrary, the number of players has even gone down, following an announcement in February that Holland-based Rusch was to shut down its high-reach demolition division.

End of Rusch's high-rise

A true pioneer in ultra high-reach applications, Rusch suffered the misfortune of coming to the market at the wrong time. When mere survival becomes an "achievement," it is next to impossible to find anyone willing to invest a few million Euros in a state-of-the-art demolition machine. Obviously, the Rusch closure does not mean the demise of the high-reach demolition idea. But with Rusch's fantastic machines gone, this part of the sector has certainly lost some of its luster.

Marketwise, Turkey, with its state-funded plans to demolish 6.5 million buildings over the next 20 years, presents international suppliers with an excellent opportunity to improve their balance sheets. But they should be prepared for stiff competition, as Turkey has some strong homegrown players, such as Hidromek, that will undoubtedly vie for a piece of action.

Three from Volvo CE

Three new models from Volvo CE—the 69ft (21m) reach EC380DHR, the 88ft (27m) reach EC480DHR, and the 105ft (32m) reach EC700CHR—offer clear proof that high-reach demolition will go on. All models are equipped as standard with a number of special features to ensure safe and productive demolition work. The bucket and boom cylinder guards protect rods and cylinders from falling debris. Another guard protects the swing ring bearing seal and grease piping from damage. The bars on the front side of the frame-mounted falling object

guard are set at angles to increase forward visibility.

Micromesh screens on doors and engine cowl keep out fine particles that could cause engine overheating. The double thickness side doors on both sides of the superstructure protect pumps and coolers. All these demolition options are bolt-on.

The EC380DHR and EC480DHR come equipped with a Volvo D13 Tier 4i/Stage IIIB-certified engine for lower emissions and increased horsepower and engine torque. Productivity is boosted with higher main hydraulic pressure and better hydraulic flow, as well as increased swing speed, travel speed, arm tear-out and bucket breakout forces.

www.volvoce.com

NHC to premier two mid-size crawlers

NHC used Bauma to introduce the Tier 4-compliant mid-size crawler excavators E75C SR and E85C MSR. A direct injection turbo-charged engine meeting the Tier 4 final emissions standards powers both models. The cooled exhaust gas recirculation technology combined with a simple diesel oxidation catalyst after-treatment system makes redundant a particulate filter, so all the fuel can be used to power the machine.

The new crawlers are equipped with an updated version of the intelligent total control system that regulates all the functions. The system relies on pressure sensors and a pump solenoid valve to ensure quick response to sudden changes in hydraulic load, thus minimizing wasted output. NHC claims this process increases fuel efficiency by 31%.

Since the E75C SR and E85C MSR are marketed as compact crawler excavators, their new EVO cabs have all the comfort of a big machine. The EVO cab is compliant with ROPS and FOPS Level II standards. For extreme applications, operator and machine safety can be further increased with the optional front and lower frame guards.

www.newholland.com

Doosan beefs up its mid-range

Doosan Infracore Construction Equipment displayed a new large crawler, designed to handle a broad range of applications, such as heavy earthmoving, road building, civil engineering, demolition, quarrying and large scale material-handling.

The Stage IIIB-compliant DX380LC-3 is designed to compete in the 34t to 42t segment with improved visibility, comfort and productivity. Controllability is also enhanced, thanks to a joggle/shuttle control, an exclusive feature on new Doosan excavators. The machine is powered by the Doosan DL08K common rail 6-cylinder turbocharged diesel engine meeting Stage IIIB engine emission regulations through the use of exhaust gas recirculation and diesel particulate filter after-treatment technologies.

A new travel device in the DX380LC-3 has increased drawbar pull by 15% to 36.9t, and produced a 15% increase in swing torque. A 10ft (3m) undercarriage and a two-mode floating boom system is optional. In the flotation mode, the boom is free to move up and down following the bucket and arm movements, whilst in the breaker mode, the boom is free





Hitachi spruces up its ZX470LCH-5

Premiered at Intermat a year ago, the ZX470LCH-5 is a dedicated high-reach demolition model, available in 82ft (25m) or 88ft (27m) configuration. According to Hitachi, customer feedback played a vital part in the development of this machine. Visibility has been enhanced using the pillarless glass of the cab, while the upper horizontal part of the window frame has been removed to give an uninterrupted view of demolition work. The FOPS and OPG-certified cab can be inclined by as much as 30° to further boost visibility.

The control panel incorporates the monitor featuring a swing angle alarm, which highlights when the machine swing comes close to its limit. Another safety warning appears with the HRD overload warning system. The monitor also displays a front attachment mode selector, which allows the operator to change the machine hydraulic circuit to match the installation of a specific attachment.

www.hcme.com

Sennebogen takes a lofty approach to demolition

Bavaria-based Sennebogen is perhaps better known for its cranes and material handlers than demolition excavators. But that does not mean that the German manufacturer has nothing to offer to demolition contractors.

Sennebogen's demolition-specific model 830 R-HDD has proved itself on some challenging jobs, including a bridge renovation project at Marktl in 2011. This 43t excavator has a reach of 54ft (16.5m) when fitted with a bucket, sorting grab, or demolition tool. The telescopic crawler undercarriage widens from 10ft (3m) in transport mode to 15ft (4.5m) for higher stability in operation.

But what sets the 830 R-HDD apart from its competition is the original design solution that allows the cab to be elevated by as much as 9ft (2.7m) for better visibility.

www.sennebogen.com

Liebherr's new R 946 demolition excavator at Bauma

At Bauma Liebherr will introduce its new R946 crawler excavator for demolition work complying with the Stage IIIB / Tier 4i exhaust emission limits. The new machine is based on the R946 standard crawler excavator and possesses all the advantages of the standard version, including increased performance potential, greater convenience for the driver and simplified maintenance. Special importance is attached to the integrated excavator-system technology, and ensures fast, smooth operating movements. It has the dual-circuit Positive Control hydraulic system and compared with other systems, it avoids waste of energy by reducing and in some cases entirely eliminating pressure losses. The driver senses the action of the load-dependent volume distribution principle as harmonious, natural movement sequences.

Another special feature of the R946 Demolition excavator is the integrated double Likifix quick-change system. The first Likifix is mounted on the end of the standard dipper stick, and forms the connection with the second dipper stick. This has the second Likifix attached to the outer end. The double Likifix enables the second dipper stick to be discarded in less than a minute, so that the excavator can perform normal digging tasks with a backhoe. The excavator can also be equipped with a variety of tools, such as sorter grab, hydraulic hammer, shears or pulveriser, and in this way its operating flexibility greatly enhanced.

The R946 Demolition excavator exhibited at the Bauma will be equipped with a 4.3m long boom and a 3.3m long dipper stick. With its second, 3m long dipper stick, this special-purpose excavator can reach heights of up to 13m. A full range of safety options is available to protect the excavator against falling material during demolition work of this kind. **(pda)**

www.liebherr.com

to move down to maintain the optimum hammering effect.

www.doosan.com

JCB improves fuel efficiency of JS range

JCB offers extra duty versions of the JS260, JS330, and JS360 excavators. Tailor-made for demolition, each machine features a strengthened boom and dipper, side and rear impact protection, undercarriage guards and plating, side rail protection systems, and FOPS cab guards with a host of additional options. Fuel efficiency on these new models has been improved by 8%.

These improvements have been achieved by using the same hydraulic technology and revised electronic control system in the heavier models as their smaller stablemates. The new excavators are Tier 4i compliant with Isuzu engines and incorporate a variable geometry turbocharger, exhaust gas recirculation, and diesel particulate filter.

www.jcb.com





**Our attachments
are like
any others...
... except
a few details
that make all
the difference**



ARDEN
EQUIPMENT

14, avenue de l'Industrie
F-08013 CHARLEVILLE-MÉZIÈRES Cedex

Tél. : +33 (0)3.24.33.64.30
Fax : +33 (0)3.24.33.64.32

E-mail : arden-equipment@arden-equipment.com



Scanmaskin is Setting and Polishing Center f

Known to be the most rugged and reliable floor grinding machines on the market, Scan Combiflex grinders are designed to withstand harsh conditions and strenuous use, making them a perfect solution for every type of grinding, prep, or polishing application in existence. Scanmaskin has recently opened up a new office in the USA, located outside of Seattle, WA. They're looking forward to expanding their operations in North America, while giving some challenging competition to other well known brands.

Below to the right, Josh Headings, responsible for the US operations, together with one of the company's US dealers.



Scanmaskin, the manufacturer of machines and systems for floor grinding, surface preparation and polishing equipment since 2004, has showed some impressive growth over the last decade. This has included the continual development of their product range, which allows them to offer effective solutions to virtually every type of customer. They have greatly expanded their line of Scan Combiflex grinders, along with increasing their diamond tooling options.

The company's export activities has also taken off, with the product range now available around the world. Strong markets include Scandinavia and countries throughout Europe, Australia, Japan and the Middle East.

During the last 12 months, Scanmaskin has begun focusing on the North American market. Following an impressive debut at the 2013 World of Concrete show, the company recently set up a subsidiary in Bellevue, Wash., and has begun searching for distributors. The US office is currently being managed by Josh Headings, who is responsible for setting up distributors and providing product and customer support throughout the US. The goal for the second year is to expand into Canada and Mexico, creating a network of distributors that covers all of North America.

"With the opening of the new US office, Scanmaskin is expecting to increase their market share substantially. One of our company slogans reflects our commitment to quality and customer service - "only the best is good enough," say Josh Headings.

The Range

Scanmaskin has a wide range of grinding and polishing machines, including the 11-model Scan Combiflex line of grinders, which was introduced in 2004. The first model to be produced was the SC 45, a small planetary machine that was compact in size and easy to transport. This initial model quickly became a bestseller, and proved itself to be a robust and popular machine for rental companies and flooring contractors alike.



The Scan Combiflex 800 (SC 800) is a robust and stable machine made of steel, designed for high productivity in large areas. The SC 800 has three grinding heads, which spin in a counter-rotating configuration for increased efficiency and smooth operation. This allows the machine to grind or polish at higher speeds, while at the same time minimizing side torque and stress on the operator.





g Up Grinding for the Americas

Since then, the grinder line has rapidly expanded to include a total of seven base models, with numerous variants and options available for the most popular models. The focus is mainly on concrete floor preparation, but Scanmaskin also has models for grinding wooden floors.

The Scanmaskin ScanOn line of diamond tooling also offers superior performance and reliability in virtually any type of application. The different ScanOn tooling options provide solutions for everything from removing tough overlays and epoxy to grinding and polishing high-gloss concrete and natural stone floors.

The versatile line of tooling is also interchangeable with each model of grinder Scanmaskin manufactures, making it easy and cost-effective to change tooling from one Combiflex grinder to another. All of the Scanmaskin grinders and dust collectors are produced at the company's headquarters in Lindome, Sweden.

"Our goal is to provide high-quality products that will provide the end user with reliability and ease of use," says founder and President of Scanmaskin Claes-Goran Bergstrand. "At Scanmaskin, we engineer our equipment to work—not to be worked on. We are continually working to improve our product line, and create cost effective solutions for customers."

The Market

Scanmaskin also has a sister company, Scanmineral, which offers a complete product line for industrial flooring applications. These include fillers for seamless floors, natural stone overlays, colored sand, and Scanmineral's own Granuscan Color Gran-

ules. Scanmaskin currently has 19 employees working at the headquarters in Lindome, with more spread across its subsidiaries throughout Scandinavia and in the US, which opened in mid-2012. The US office is besides marketing and selling the Scanmaskin range also providing parts, service, and distributor support for all Scanmaskin products in the country.

"We already see a great potential for our machines and systems on the US market," says Bergstrand. "We are currently building up a sales and service network across the country."

Scanmaskin wants to continue its expansion not only in North America but also in South America.

"The floor preparation industry is really picking up in South America and also in Mexico, and we are looking for companies that can represent our product line," says Scanmaskin Marketing Manager Paulo Bergstrand. pdamericas.com

www.scanmaskin.com

Claes-Goran Bergstrand showing a new tool designed for profiling concrete surfaces, comparable to shot blasting. Introduced at World of Concrete 2013.

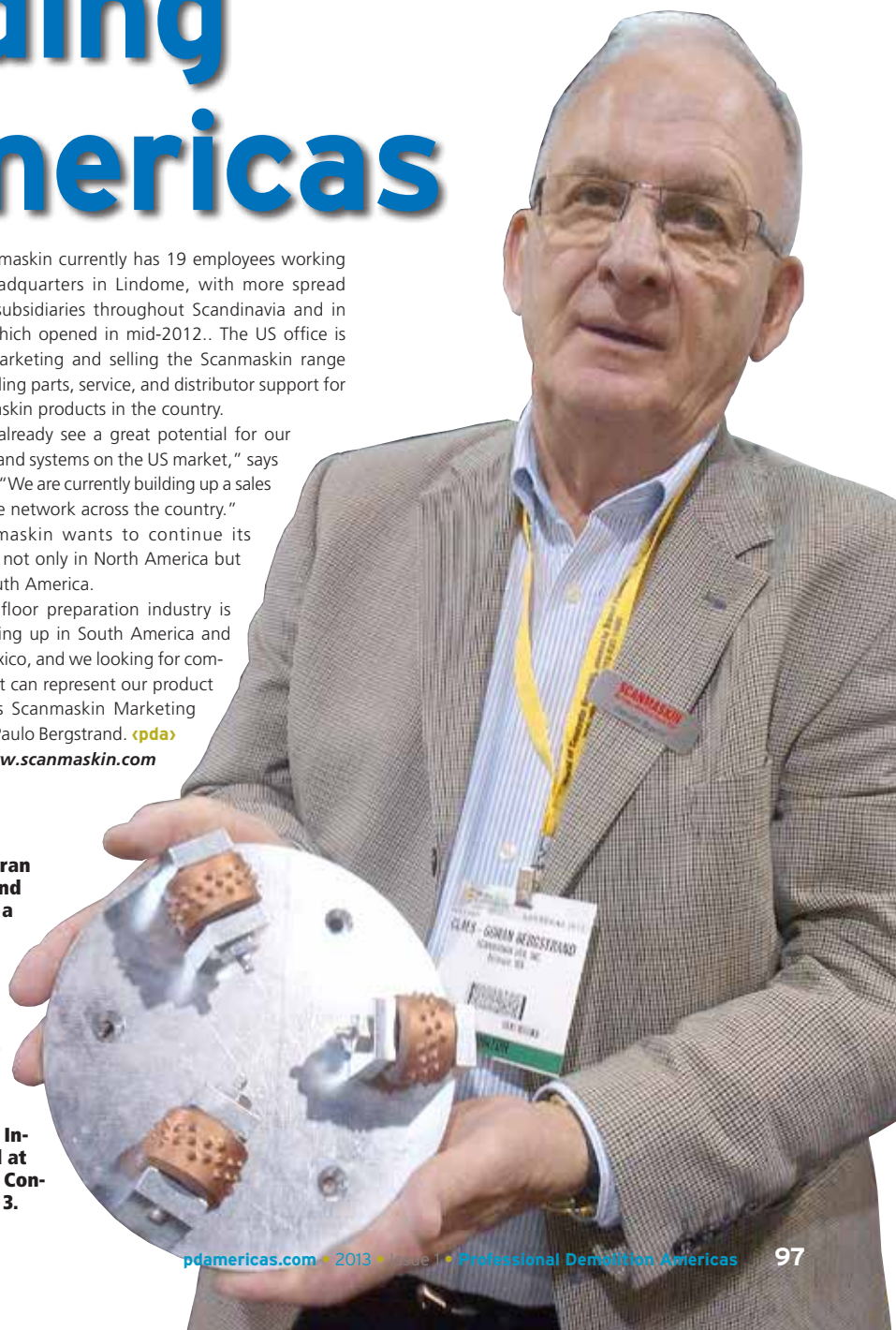

Smart Control Solutions for Mobile Machinery

Extensive experience and know-how of mobile machines and special vehicles creates the foundation for Epec's ability to help machine manufacturers and partners develop efficient, safe, and environmentally friendly mobile machines and utility vehicles, enabling end-users to maximize their productivity.

Epec Oy is a solution provider specializing in embedded control systems, vehicle computers, and information logistics systems for mobile machines and utility vehicles. In addition to its line of quality-manufactured products, services such as training and customer support are all available along with Epec's technical expertise.

Smart machines get smarter

Epec's client base is both local and international, with the business unit including manufacturing is located in Finland. Local support and quality services can also be found across Epec's growing international network of partners, conveniently serving their local markets. Machines and vehicles today must offer advantages through productivity, performance, and dependability. They should



be efficient and cost-effective in order to achieve full machine potential.

Embedded control systems and vehicle computers help define expected machine standards.

They increase machine efficiency and productivity by optimizing and constantly monitoring and diagnosing loads, pressures, temperatures, and other functions around the machine, engine, etc. Optimum performance and high output capability can be expected from machines with these intelligent systems, contributing to machine's full potential, and supporting the overall process performance for effectively carrying out work.

For challenging conditions

All Epec mobile electronic control units (ECUs) can be used in rough terrain and challenging conditions. They have a wide operating temperature range, and high endurance against difficult and demanding environmental conditions. Epec ECUs, embedded displays, and vehicle computers can be found from the range of products listed in the following pages. Products comply with normal automotive standards for electromagnetic compatibility (EMC) and environmental conditions, and are certified for automotive use according to e17.

Open and compatible

Embedded control systems are based on PLCopen programming and the CANopen® communication protocol, making them easily scalable to meet requirements for both small and large machines.

ECUs have open I/O and communication interface, which makes it easier to connect devices from other manufacturers to optimize the whole machine environment both technically and ergonomically. In addition to CANopen®, both SAE J1939 and ISOBUS are also available.

Embedded Control Units

Embedded control units are basic building blocks of machine control systems. Each unit can act as an independent control unit in smaller systems, or as a part in a total control system. They are compact multifunction controllers, and have open I/O interfaces for easy connection with sensors, actuators, joysticks, and other devices from most common manufacturers.

The design and unique shape of the control unit casing helps protect the electronics inside against mechanical wear. Because all control units are used in difficult environmental conditions, they must easily endure cold, heat, vibration, moisture, and hard impacts. Epec control units can handle impacts up to 100G, and meet the IP67 standard for water and dust protection. Combined with the functional design of the control unit casing, Epec components are easy to install as the control unit seldom requires any extra protection.

Up to four CAN bus interfaces increase the possibilities of connecting other CAN devices with the control unit. They also provide a communication solution for the control system's internal communication. With several CAN bus interfaces, these control units are also capable to work as a gateway between different CAN buses. The CANopen® communication protocol provides easy communication with other CANopen® devices. And with the SAE J1939 communication protocol, all the communication with modern diesel engines and transmissions, etc., is also easy.

Drawing on its vast experience with a variety of control systems for challenging conditions, Epec is able to offer a total solution, from control units to project services and designing. Epec help their customers and partners design and manufacture safe, efficient, and environmentally friendly mobile working machines, which enable machine users to maximize their productivity.

Epec has a strong position as a control system designer and manufacturer for mobile machines, electronics and software for challenging conditions. Epec's main customers include global machine and utility vehicle manufacturers. In addition to a strong share in the domestic market, Epec products are widely exported to Europe, the Far East, Russia, and North America.

Control system pioneer

Epec has helped pioneer advancements in distributed control systems in mobile machinery. Currently, the company is focusing on programmable control and information systems for mobile working machines and utility vehicles. All Epec products are manufactured in Finland. Highly automatized production lines and dedicated processes are utilized to produce high quality devices for global OEM customers and system integrators. In the past few years, the company has focused on seeking growth outside Finland. At the moment, Epec exports directly to more than 20 countries. In China, Epec has been able to gain market leadership as a control systems' manufacturer; a position the company intends to maintain in the future.

www.epec.fi

BROKK 60

Introducing:

The world's smallest giant



TUNNELING

CEMENT

PROCESS

NUCLEAR

CONSTRUCTION

MINING

INTRODUCING BROKK 60 – THE NEXT BIG THING IN REMOTE-CONTROLLED DEMOLITION

With the Brokk 60 we have taken another leap forward in safe and effective confined-space demolition. It is many times more productive than handheld equipment, yet so compact and nimble that it works wonders in places where traditional demolition machines simply cannot go.

Compared to its older brother, the Brokk 50, it boosts productivity by almost 25% with more power from the breaker, faster, more precise movements, a new control system, and an even lower profile. The low weight – only about half a ton – makes it perfect for interior demolition on standard floors and it can easily fit in an ordinary passenger elevator. It can even 'walk' up and down stairs.

The all new Brokk 60 – A true giant. Except for the size.

Original Demolition Power™

BROKK®



IMPRESSIVE
Performance
!!!



Reliable Powerful High Quality Built To Last

At Pentrunder, adequate is not acceptable. Our innovative wall saws, core drills and wire saws are created by the industry's most experienced design team to be the best in the business. Each is crafted with highest-quality components and parts that are precision machined in our own state-of-the-art factory. Our worldwide dealer network supports the thousands of Pentrunder owners and operators who daily out-perform their competition.

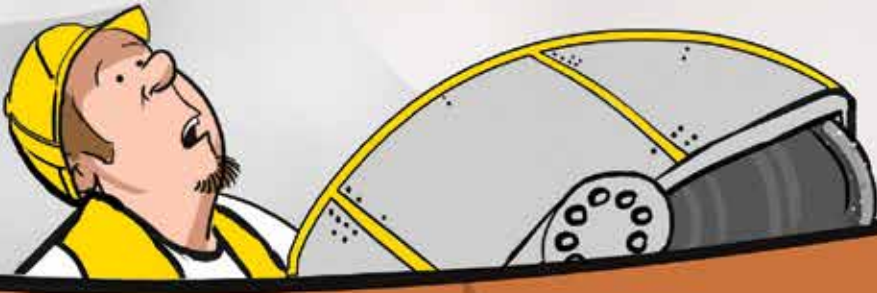

Pentrunder, Inc. Sales and Service
562-445-6429, Fax: 480-966-2386
terry@pentrunderinc.com
www.pentrunder.com